



Meaningful Innovation.

WEEE Number: 80133970

INSTRUCTION MANUAL

ALUMINIUM PROFILE



02 METER
LENGTH

INTRODUCTION

Thank you for selecting and buying V-TAC product. V-TAC will serve you the best. Please read these instructions carefully before starting the installation and keep this manual handy for future reference. If you have any another query, please contact our dealer or local vendor from whom you have purchased the product. They are trained and ready to serve you at the best.

MAINTENANCE

- **Pre-Cleaning Precautions:** Prior to cleaning the product, ensure it is disconnected from the mains voltage. This is a crucial safety measure to prevent any electrical mishaps.
- **Cleaning Procedure:** Utilize a cotton cloth lightly dampened with alcohol to clean the frame. Refrain from using potent chemical agents. It's imperative to ensure that the liquid does not come into contact with the electrical components of the product.
- **Safety Measures:** Cleaning should not be undertaken by children under the age of 8, unless they are under adult supervision. This is to ensure the safety of the child and the proper handling of the product.
- **Cutting the Profile:** Secure the aluminum profile in place using a vice or clamps to ensure it doesn't move while cutting. Ensure the cut is as straight as possible for the best fit.
- **Smooth the Edges:** After cutting, the edges of the aluminum profile might be sharp or uneven. Use a file to smooth these out, taking care to remove any metal burrs that could potentially cause harm.

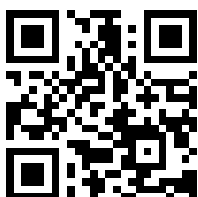

MULTI-LANGUAGE MANUAL QR CODE

Please scan the QR code to access the manual in multiple languages.



This marking indicates that this product should not be disposed of with other household wastes.

INSTALLATION INSTRUCTIONS

RECESSED INSTALLATION

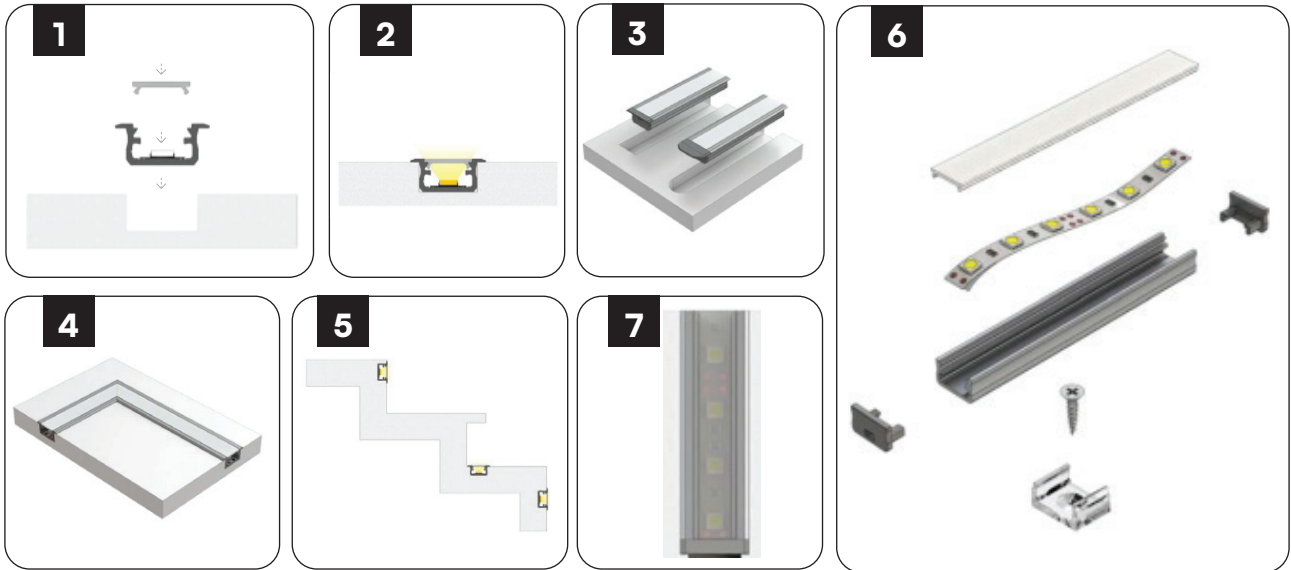

SURFACE INSTALLATION

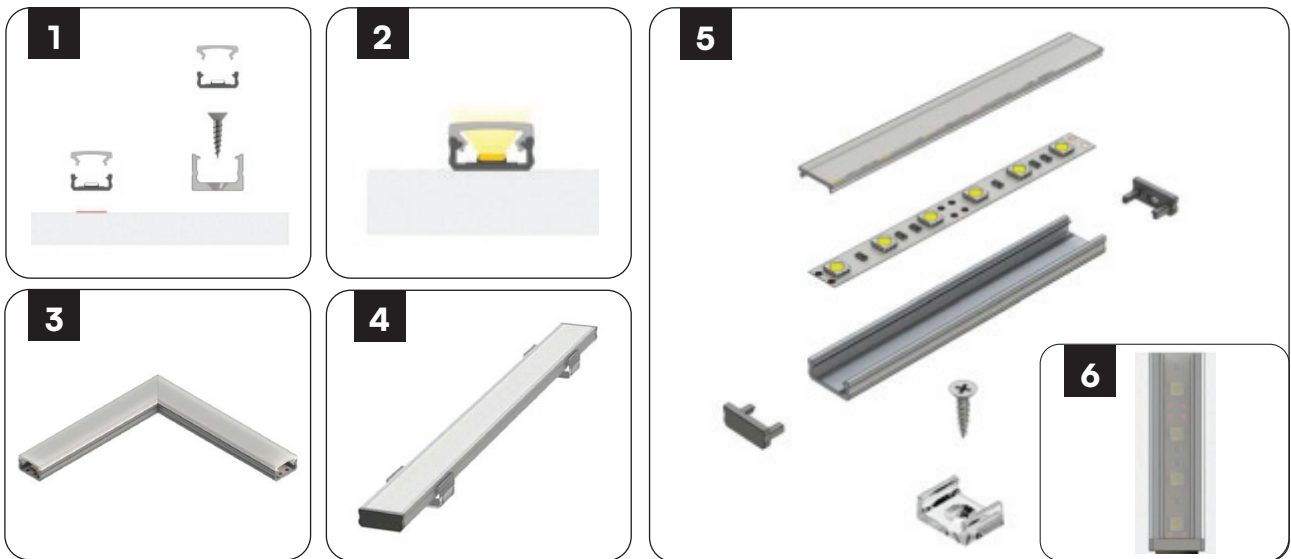

GYPSUM INSTALLATION

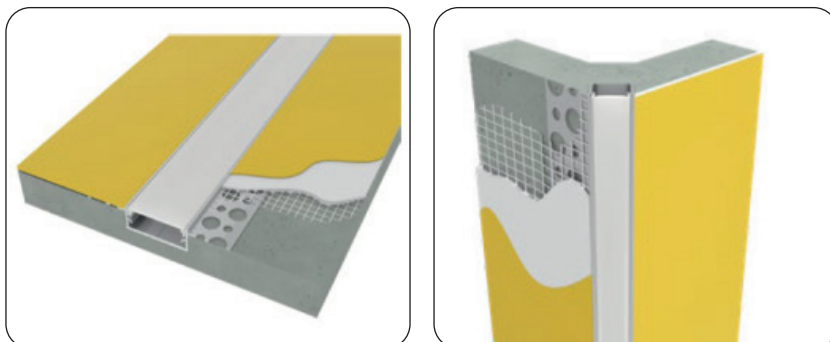

CORNER INSTALLATION

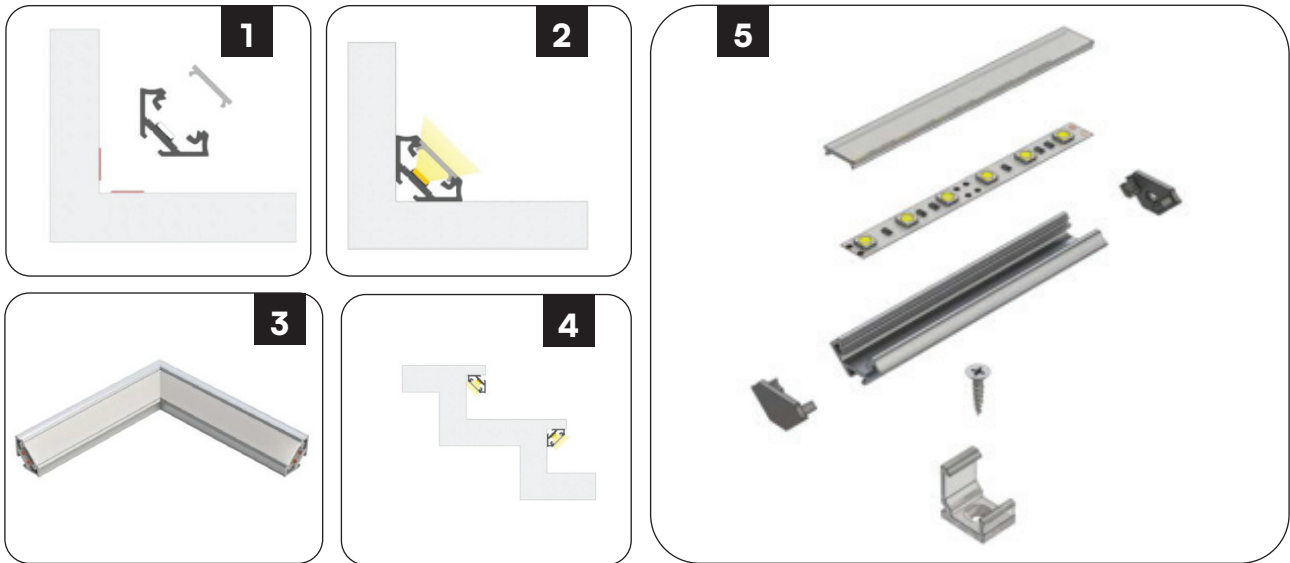

PRODUCT DESCRIPTIONS

SKU	DESCRIPTION
3350	VT-8106 MOUNTING KIT WITH DIFFUSER FOR LED STRIP RECESSED 2000X24.7X7MM SILVER
3351	VT-8107 MOUNTING KIT WITH DIFFUSER FOR LED STRIP RECESSED 2000X24X14.2MM SILVER
3352	VT-8108 MOUNTING KIT WITH DIFFUSER FOR LED STRIP SURFACE 2000X23.5X10MM SILVER
3353	VT-8109 MOUNTING KIT WITH DIFFUSER FOR LED STRIP CORNER 2000X15.8X15.8MM SILVER
3354	VT-8110 MOUNTING KIT WITH DIFFUSER FOR LED STRIP SURFACE 2000X17.2X14.44MM SILVER
3355	VT-8113 MOUNTING KIT WITH DIFFUSER FOR LED STRIP SURFACE 2000X17.4X7MM SILVER
3356	VT-8114 MOUNTING KIT WITH DIFFUSER FOR LED STRIP CORNER 2000X19X19MM SILVER
3357	VT-8115 MOUNTING KIT WITH DIFFUSER FOR LED STRIP RECESSED 2000X24.5X12.2MM SILVER
3358	VT-8116 MOUNTING KIT WITH DIFFUSER FOR LED STRIP SURFACE 2000X17.4X12.1MM SILVER
3359	VT-8101 MOUNTING KIT WITH DIFFUSER FOR LED STRIP RECESSED 2000x61.5x14MM SILVER
3360	VT-8102 MOUNTING KIT WITH DIFFUSER FOR LED STRIP RECESSED 2000x52.1x13.3MM SILVER
3361	VT-8103 MOUNTING KIT WITH DIFFUSER FOR LED STRIP 2000x50.12x22.34MM SILVER
3362	VT-8104 MOUNTING KIT WITH DIFFUSER FOR LED STRIP RECESSED 2000x45.4x25.14MM SILVER
3363	VT-8105 MOUNTING KIT WITH DIFFUSER FOR LED STRIP CORNER 2000x20.3x30MM SILVER
3364	VT-8114-W MOUNTING KIT WITH DIFFUSER FOR LED STRIP PCB 12MM CORNER 2000X19X19MM WHITE
3365	VT-8113-W MOUNTING KIT WITH DIFFUSER FOR LED STRIP PCB 12MM SURFACE 2000X17.4X7MM WHITE
3366	VT-8110-W MOUNTING KIT WITH DIFFUSER FOR LED STRIP PCB 20MM SURFACE 2000X17.2X14.44MM WHITE
3367	VT-8108-W MOUNTING KIT WITH DIFFUSER FOR LED STRIP PCB 20MM SURFACE 2000X23.5X10.4MM WHITE
3368	VT-8122 MOUNTING KIT WITH DIFFUSER FOR LED STRIP PCB 12MM RECESSED 2000X24.7X7MM WHITE
3369	VT-8123 MOUNTING KIT WITH DIFFUSER FOR LED STRIP PCB 12MM CORNER 2000X15.8X15.8MM WHITE
3370	VT-9327 MOUNTING KIT WITH DIFFUSER FOR LED STRIP SURFACE 2000X15.55X5.9MM SILVER
3371	VT-8118 MOUNTING KIT WITH DIFFUSER FOR LED STRIP SURFACE 2000X30X20MM SILVER
3372	VT-8119 MOUNTING KIT WITH DIFFUSER FOR LED STRIP RECESSED 2000X30X20MM SILVER

9956	VT-7104 MOUNTING KIT WITH DIFFUSER FOR LED STRIP CORNER 2000MM SILVER(2PCS PACK)
2610	VT-8117 MOUNTING KIT WITH DIFFUSER FOR LED STRIP SURFACE 2000MM NEON FLEX
2871	VT-8126 MOUNTING KIT WITH DIFFUSER FOR LED STRIP RECESSED 2000x50x35mm WHITE
2872	VT-8127 MOUNTING KIT WITH DIFFUSER FOR LED STRIP SURFACED 2000x50x75mm WHITE
2873	VT-8113 MOUNTING KIT WITH DIFFUSER FOR LED STRIP 2000x17.4x7mm BLACK
2874	VT-8109 MOUNTING KIT WITH DIFFUSER FOR LED STRIP 2000x15.8x15.8mm BLACK
2875	VT-8106 MOUNTING KIT WITH DIFFUSER FOR LED STRIP 2000x24.7x7mm BLACK
2876	VT-8108 MOUNTING KIT WITH DIFFUSER FOR LED STRIP 2000x23.5x10mm BLACK
2877	VT-8114 MOUNTING KIT WITH DIFFUSER FOR LED STRIP 2000x19x19mm BLACK
2878	VT-8110 MOUNTING KIT WITH DIFFUSER FOR LED STRIP 2000x17.2x14.4mm BLACK
2903	VT-8136 MOUNTING KIT WITH DIFFUSER FOR LED STRIP SURFACED 2000MM
2904	VT-8137 MOUNTING KIT WITH DIFFUSER FOR LED STRIP RECESSED 2000MM
2909	VT-8138 MOUNTING KIT WITH DIFFUSER BENDABLE FOR LED STRIP 2000x18x6MM SILVER HOUSING
10320	VT-8156 MOUNTING KIT WITH DIFFUSER FOR LED STRIP 2000x24.7x7mm
10321	VT-8157 MOUNTING KIT WITH DIFFUSER FOR LED STRIP 2000x17.4x7mm
10322	VT-8158 MOUNTING KIT WITH DIFFUSER FOR LED STRIP 2000x15.8mmx15.8mm
23173	VT-8201 MOUNTING KIT WITH DIFFUSER FOR LED STRIP 2000x55x15mm SILVER BODY
23174	VT-8202 MOUNTING KIT WITH DIFFUSER FOR LED STRIP 2000x20x10mm SILVER BODY
23175	VT-8203 MOUNTING KIT WITH DIFFUSER FOR LED STRIP 2000x20x10mm SILVER BODY
23176	VT-8204S MOUNTING KIT WITH DIFFUSER FOR LED STRIP 2000x30x10mm SILVER BODY
23177	VT-8204 MOUNTING KIT WITH DIFFUSER FOR LED STRIP 2000x30x10mm SILVER BODY
23178	VT-8206S MOUNTING KIT WITH DIFFUSER FOR LED STRIP 2000x50x20mm SILVER BODY
23179	VT-8206 MOUNTING KIT WITH DIFFUSER FOR LED STRIP 2000x50x20mm SILVER BODY
23180	VT-8208 MOUNTING KIT WITH DIFFUSER FOR LED STRIP 2000x60x36mm SILVER BODY



Meaningful Innovation.

WEEE Number: 80133970

РЪКОВОДСТВО ЗА УПОТРЕБА

АЛУМИНИЕВ ПРОФИЛ



02 METER
LENGTH

ВЪВЕДЕНИЕ

Благодарим ви, че избрахте и закупихте продукт на V-TAC. V-TAC ще ви служи по най-добрия начин. Моля, прочетете внимателно тези инструкции, преди да започнете монтажа, и съхранявайте това ръководство за бъдещи справки. Ако имате някакви други въпроси, моля, свържете се с нашия дилър или с местния продавач, от когото сте закупили продукта. Те са обучени и са готови да ви обслужат по най-добрия начин.

ПОДДЪРЖАНЕ

- **Предпазни мерки преди почистване:** Преди почистване на продукта се уверете, че той е изключен от електрическата мрежа. Това е изключително важна мярка за безопасност, за да се предотвратят всякакви електрически злополуки.
- **Процедура за почистване:** Използвайте памучна кърпа, леко навлажнена със спирт, за да почистите рамката. Въздържайте се от използване на мощни химически агенти. Задължително е да се гарантира, че течността няма да влезе в контакт с електрическите компоненти на продукта.
- **Мерки за безопасност:** Почистването не трябва да се извършва от деца под 8 години, освен ако те не са под надзор от възрастни. Това се прави, за да се гарантира безопасността на детето и правилното боравене с продукта.
- **Изрязване на профила:** Закрепете алуминиевия профил на място с помощта на тиранти или скоби, за да не се движи по време на рязане. Уверете се, че рязането е възможно най-правилно за най-добро прилягане.
- **Изглаждане на ръбовете:** След рязане ръбовете на алуминиевия профил може да са остри или неравни. Използвайте пила, за да изгладете ги, като внимавате да отстраните всички метални грапавини, които биха могли да причинят вреда.



Тази маркировка показва, че този продукт не трябва да се изхвърля заедно с други битови отпадъци.

В СЛУЧАЙ НА ЗАПИТВАНЕ/ПРОБЛЕМ С ПРОДУКТА, МОЛЯ, СВЪРЖЕТЕ СЕ С НАС НА: SUPPORT@V-TAC.EU ЗА ПОВЕЧЕ ПРОДУКТОВА ГАМА, ЗАПИТВАНЕ, МОЛЯ, СВЪРЖЕТЕ СЕ С НАШИЯ ДИСТРИБУТОР ИЛИ НАЙ-БЛИЗКИТЕ ДИЛЪРИ.

V-TAC EUROPE LTD. БЪЛГАРИЯ, ПЛОВДИВ 4000, BUL.L.KARAVELOW 9B

ИНСТРУКЦИИ ЗА ИНСТАЛИРАНЕ НА ВГРАДЕНА ИНСТАЛАЦИЯ

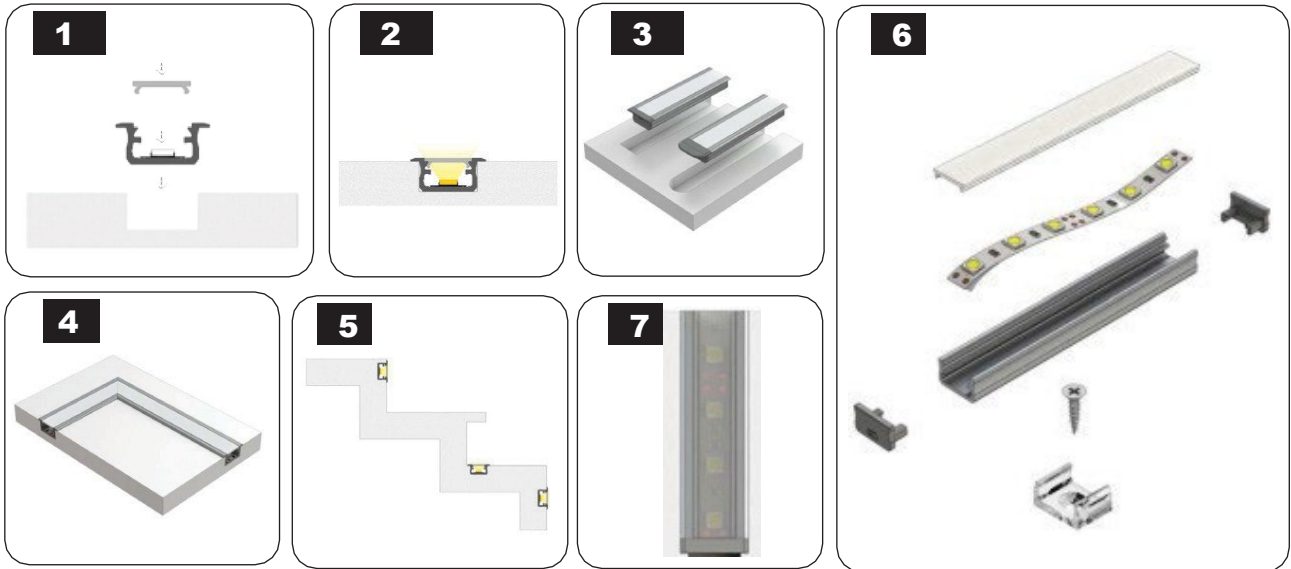

ПОВЪРХНОСТЕН МОНТАЖ



МОНТАЖ НА ГИПС

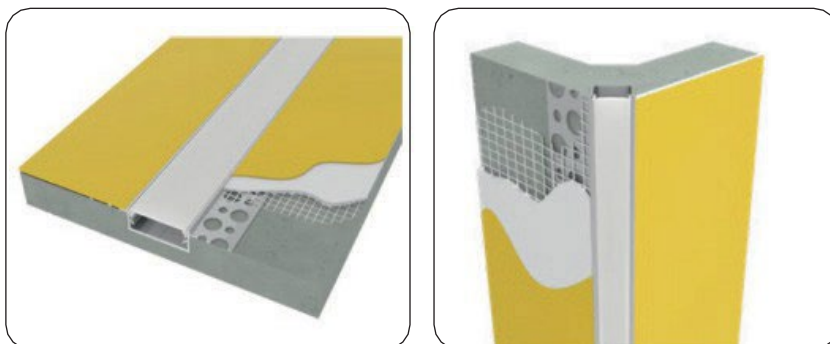

ЪГЛОВ МОНТАЖ

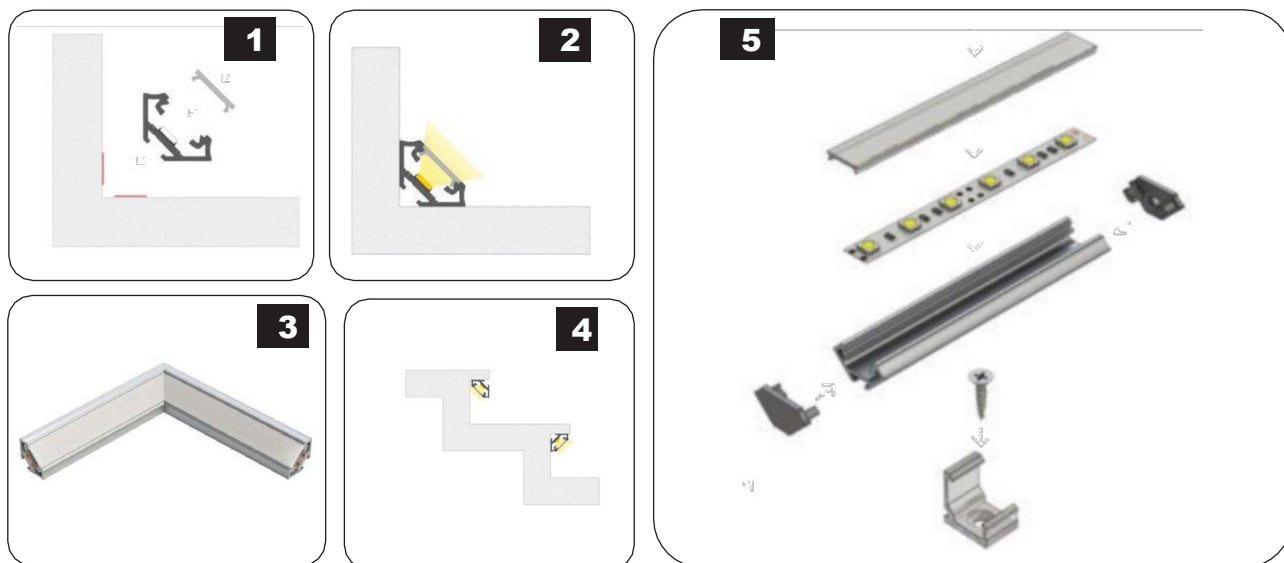

ОПИСАНИЯ НА ПРОДУКТИ

SKU	ОПИСАНИЕ
3350	VT-8106 МОНТАЖЕН КОМПЛЕКТ С РАЗСЕЙВАТЕЛ ЗА СВЕТОДИОДНА ЛЕНТА ЗА ВГРАЖДАНЕ 2000X24.7X7MM SILVER
3351	VT-8107 МОНТАЖЕН КОМПЛЕКТ С РАЗСЕЙВАТЕЛ ЗА LED ЛЕНТА ЗА ВГРАЖДАНЕ 2000X24X14.2MM СРЕБРИСТ
3352	VT-8108 МОНТАЖЕН КОМПЛЕКТ С РАЗСЕЙВАТЕЛ ЗА СВЕТОДИОДНА ЛЕНТА ЗА ПОВЪРХНОСТ 2000X23.5X10MM СРЕБРО
3353	VT-8109 МОНТАЖЕН КОМПЛЕКТ С РАЗСЕЙВАТЕЛ ЗА LED ЛЕНТА ЪГЪЛ 2000X15.8X15.8MM СРЕБРО
3354	VT-8110 МОНТАЖЕН КОМПЛЕКТ С РАЗСЕЙВАТЕЛ ЗА СВЕТОДИОДНА ЛЕНТА ЗА ПОВЪРХНОСТ 2000X17.2X14.44MM СРЕБРО
3355	VT-8113 МОНТАЖЕН КОМПЛЕКТ С РАЗСЕЙВАТЕЛ ЗА СВЕТОДИОДНА ЛЕНТА ЗА ПОВЪРХНОСТ 2000X17.4X7MM СРЕБРО
3356	VT-8114 МОНТАЖЕН КОМПЛЕКТ С РАЗСЕЙВАТЕЛ ЗА LED ЛЕНТА В ЪГЪЛА 2000X19X19MM СРЕБРИСТ
3357	VT-8115 МОНТАЖЕН КОМПЛЕКТ С РАЗСЕЙВАТЕЛ ЗА LED ЛЕНТА ЗА ВГРАЖДАНЕ 2000X24.5X12.2MM СРЕБРИСТ
3358	VT-8116 МОНТАЖЕН КОМПЛЕКТ С РАЗСЕЙВАТЕЛ ЗА СВЕТОДИОДНА ЛЕНТА ЗА ПОВЪРХНОСТ 2000X17.4X12.1MM СРЕБРО
3359	VT-8101 Комплект за монтаж с дифузер за светодиодна лента с речеция 2000x61.5x14MM SILVER
3360	VT-8102 Комплект за монтаж с дифузер за светодиодна лента с вдлъбнатини 2000x52.1x13.3 мм сребрист
3361	VT-8103 Комплект за монтиране с дифузер за светодиодна лента 2000x50.12x22.34MM SILVER
3362	VT-8104 Комплект за монтаж с дифузер за светодиодна лента с речеция 2000x45.4x25.14MM SILVER
3363	VT-8105 Комплект за монтиране с дифузер за LED лента за ъгъл 2000x20.3x30MM SILVER
3364	VT-8114-W МОНТАЖЕН КОМПЛЕКТ С РАЗСЕЙВАТЕЛ ЗА СВЕТОДИОДНА ЛЕНТА ЗА ПЛАТКИ 12 MM ЪГЪЛ 2000X19X19 MM БЯЛ
3365	VT-8113-W МОНТАЖЕН КОМПЛЕКТ С РАЗСЕЙВАТЕЛ ЗА СВЕТОДИОДНА ЛЕНТА ЗА ПЛАТКИ С 12 MM ПОВЪРХНОСТ 2000X17.4X7 MM БЯЛ
3366	VT-8110-W МОНТАЖЕН КОМПЛЕКТ С РАЗСЕЙВАТЕЛ ЗА СВЕТОДИОДНА ЛЕНТА ЗА ПЕЧАТНИ ПЛАТКИ С 20 MM ПОВЪРХНОСТ 2000X17.2X14.44 MM БЯЛ
3367	VT-8108-W МОНТАЖЕН КОМПЛЕКТ С РАЗСЕЙВАТЕЛ ЗА СВЕТОДИОДНА ЛЕНТА ЗА ПЛАТКИ С 20 MM ПОВЪРХНОСТ 2000X23.5X10.4 MM БЯЛ
3368	VT-8122 МОНТАЖЕН КОМПЛЕКТ С РАЗСЕЙВАТЕЛ ЗА СВЕТОДИОДНА ЛЕНТА ЗА ПЛАТКИ 12 MM ЗА ВГРАЖДАНЕ 2000X24.7X7MM БЯЛ
3369	VT-8123 МОНТАЖЕН КОМПЛЕКТ С РАЗСЕЙВАТЕЛ ЗА СВЕТОДИОДНА ПЛАТКА 12MM ЪГЪЛ 2000X15.8X15.8MM БЯЛ
3370	VT-9327 МОНТАЖЕН КОМПЛЕКТ С РАЗСЕЙВАТЕЛ ЗА СВЕТОДИОДНА ЛЕНТА ЗА ПОВЪРХНОСТ 2000X15.5X5.9MM СРЕБРО
3371	VT-8118 МОНТАЖЕН КОМПЛЕКТ С РАЗСЕЙВАТЕЛ ЗА СВЕТОДИОДНА ЛЕНТА ЗА ПОВЪРХНОСТ 2000X30X20MM СРЕБРО
3372	VT-8119 МОНТАЖЕН КОМПЛЕКТ С РАЗСЕЙВАТЕЛ ЗА LED ЛЕНТА ЗА ВГРАЖДАНЕ 2000X30X20MM СРЕБРИСТ

9956	VT-7104 МОНТАЖЕН КОМПЛЕКТ С РАЗСЕЙВАТЕЛ ЗА LED ЛЕНТА ЪГЪЛ 2000ММ СРЕБРО (2PCS ПАКЕТ)
2610	VT-8117 МОНТАЖЕН КОМПЛЕКТ С РАЗСЕЙВАТЕЛ ЗА ПОВЪРХНОСТНА СВЕТОДИОДНА ЛЕНТА 2000ММ NEON FLEX
2871	VT-8126 Комплект за монтаж с дифузер за светодиодна лента с вдлъбнатини 2000x50x35mm БЯЛ
2872	VT-8127 Комплект за монтаж с дифузер за светодиодна лента с повърхностно покритие 2000x50x75mm БЯЛ
2873	VT-8113 Комплект за монтиране с дифузер за LED лента 2000x17.4x7mm BLACK
2874	VT-8109 Комплект за монтиране с дифузер за LED лента 2000x15.8x15.8mm BLACK
2875	VT-8106 Комплект за монтиране с дифузер за LED лента 2000x24.7x7mm BLACK
2876	VT-8108 Комплект за монтиране с дифузер за LED лента 2000x23.5x10mm BLACK
2877	VT-8114 Комплект за монтиране с дифузер за LED лента 2000x19x19mm BLACK
2878	VT-8110 Комплект за монтиране с дифузер за LED лента 2000x17.2x14.4mm BLACK
2903	VT-8136 МОНТАЖЕН КОМПЛЕКТ С РАЗСЕЙВАТЕЛ ЗА СВЕТОДИОДНА ЛЕНТА С ПОВЪРХНОСТ 2000ММ
2904	VT-8137 МОНТАЖЕН КОМПЛЕКТ С РАЗСЕЙВАТЕЛ ЗА LED ЛЕНТА ЗА ВГРАЖДАНЕ 2000ММ
2909	VT-8138 Комплект за монтиране с разклонител за огъване за светодиодна лента 2000x18x6ММ Сребърен корпус
10320	VT-8156 Комплект за монтаж с дифузер за LED лента 2000x24.7x7mm
10321	VT-8157 Комплект за монтаж с дифузер за светодиодна лента 2000x17.4x7mm
10322	VT-8158 Комплект за монтаж с дифузер за LED лента 2000x15.8mmx15.8mm
23173	VT-8201 Комплект за монтиране с дифузер за светодиодна лента 2000x55x15mm Сребристо тяло
23174	VT-8202 Комплект за монтиране с дифузер за LED лента 2000x20x10mm Сребристо тяло
23175	VT-8203 Комплект за монтиране с дифузер за светодиодна лента 2000x20x10mm Сребристо тяло
23176	VT-8204S Комплект за монтиране с дифузер за светодиодна лента 2000x30x10mm Сребристо тяло
23177	VT-8204 Комплект за монтиране с дифузер за светодиодна лента 2000x30x10mm Сребристо тяло
23178	VT-8206S Комплект за монтиране с дифузер за светодиодна лента 2000x50x20mm Сребристо тяло
23179	VT-8206 Комплект за монтиране с дифузер за светодиодна лента 2000x50x20mm Сребристо тяло
23180	VT-8208 Комплект за монтиране с дифузер за светодиодна лента 2000x60x36mm Сребристо тяло



Meaningful Innovation.

WEEE Number: 80133970

UPUTE ZA UPORABU ALUMINIJSKI PROFIL

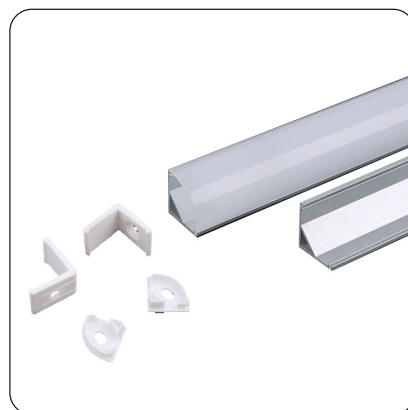

02 METER
LENGTH

UVOD

Hvala što ste odabrali i kupili V-TAC proizvod. V-TAC će vam poslužiti najbolje. Pažljivo pročitajte ove upute prije početka instalacije i držite ovaj priručnik pri ruci za buduću upotrebu. Ako imate bilo kakvih dodatnih pitanja, obratite se našem trgovcu ili lokalnom prodavaču od kojeg ste kupili proizvod. Oni su obučeni i spremni poslužiti vas na najbolji način.

ODRŽAVANJE

- **Mjere opreza prije čišćenja:** Prije čišćenja proizvoda uvjerite se da je isključen iz mrežnog napona. Ovo je ključna sigurnosna mjera za sprječavanje bilo kakvih električnih nezgoda.
- **Postupak čišćenja:** Za čišćenje okvira koristite pamučnu krpu lagano navlaženu alkoholom. Suzdržite se od korištenja jakih kemijskih sredstava. Neophodno je osigurati da tekućina ne dođe u kontakt s električnim komponentama proizvoda.
- **Sigurnosne mjere:** Čišćenje ne smiju obavljati djeca mlađa od 8 godina, osim ako nisu pod nadzorom odrasle osobe. Time se osigurava sigurnost djeteta i pravilno rukovanje proizvodom.
- **Rezanje profila:** Pričvrstite aluminijski profil na mjesto pomoću škripca ili stezaljki kako biste bili sigurni da se ne pomiče tijekom rezanja. Pobrinite se da je rez što ravniji za najbolje pristajanje.
- **Zagladite rubove:** Nakon rezanja rubovi aluminijskog profila mogu biti oštri ili neravni. Upotrijebite turpiju da ih izravnate, pazite da uklonite sve metalne oštrice koje bi potencijalno mogle prouzročiti štetu.



Ova oznaka označava da se ovaj proizvod ne smije odlagati s ostalim kućnim otpadom.

U SLUČAJU BILO KAKVOG UPITA/PROBLEMA S PROIZVODOM, OBRATITE NAM SE NA: SUPPORT@V-TAC.EU ZA VIŠE PROIZVODA. UPIT MOLIMO DA KONTAKTIRATE NAŠEG DISTRIBUTERA ILI NAJBLIŽEG TRGOVCA. V-TAC EUROPE LTD. BUGARSKA, PLOVDIV 4000, BUL.L.KARAVELOW 9B

UPUTE ZA MONTAŽU

UGRADNJA UGRADBENA

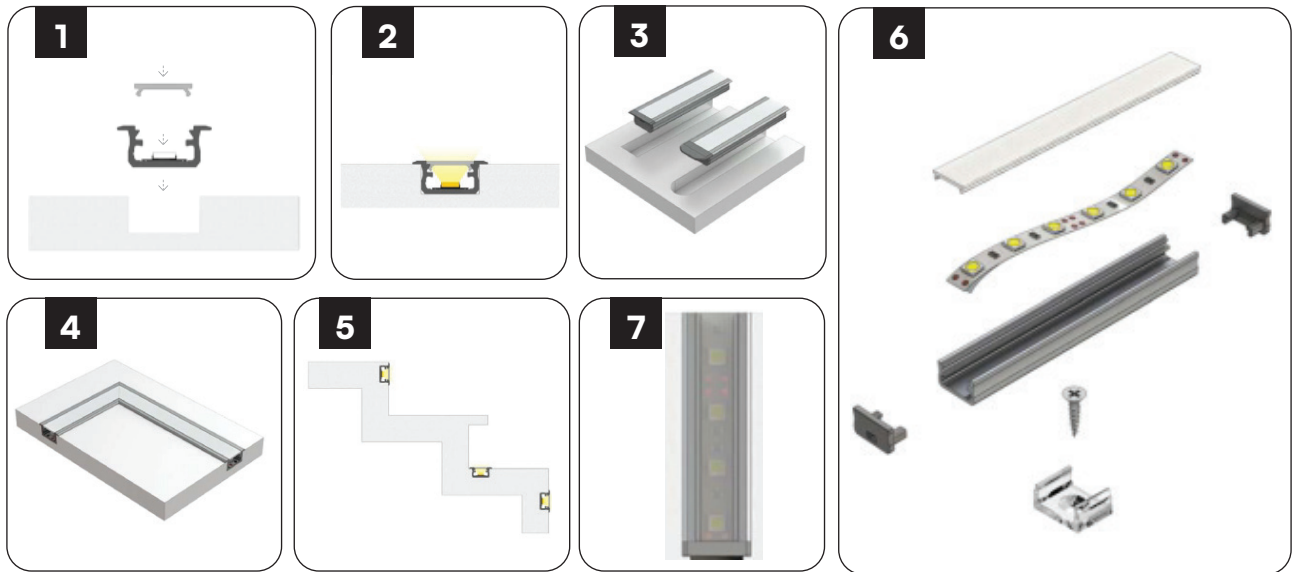

NADZIDNA UGRADNJA

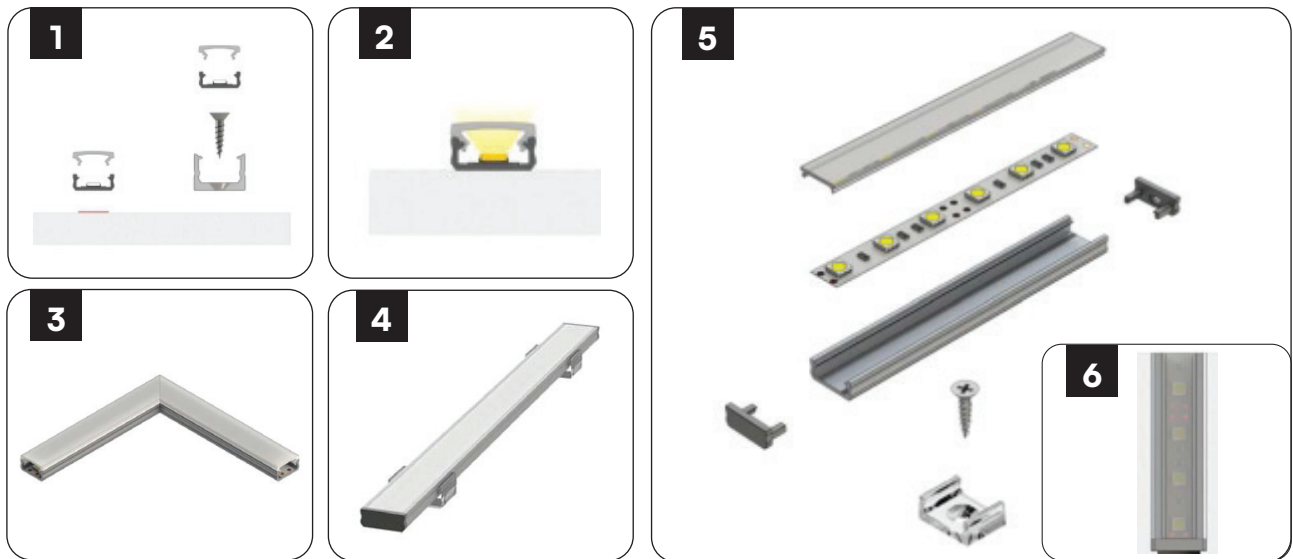

POSTAVLJANJE GIPSA

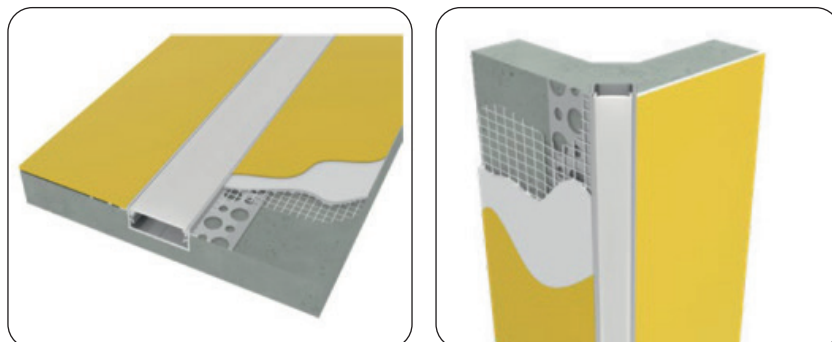

KUTNA INSTALACIJA

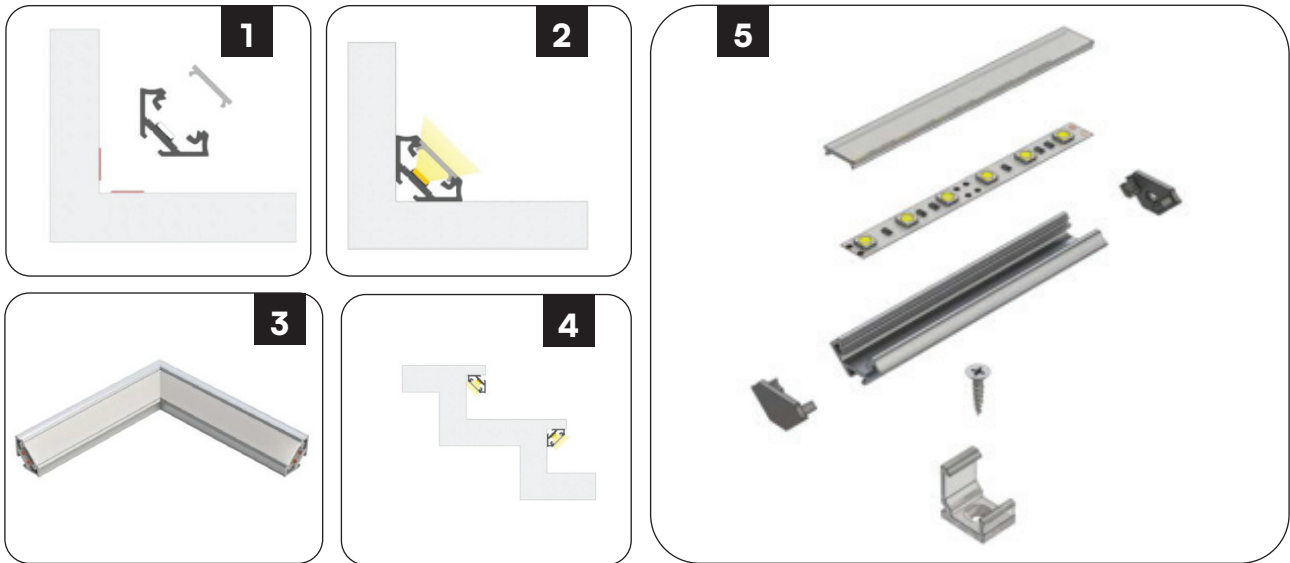

OPISI PROIZVODA

SKU	OPIS
3350	VT-8106 GARNITURA ZA MONTAŽU S DIFUZOROM ZA LED TRAKU UDUBLJENU 2000X24.7X7MM SREBRNA
3351	VT-8107 PRIBOR ZA MONTAŽU S DIFUZOROM ZA LED TRAKU UDUBLJENU 2000X24X14.2MM SREBRNA
3352	VT-8108 MONTAŽNI KIT S DIFUZOROM ZA LED TRAKU POVRŠINE 2000X23.5X10MM SREBRNA
3353	VT-8109 MONTAŽNI KIT S DIFUZOROM ZA KUTNU LED TRAKU 2000X15.8X15.8MM SREBRNA
3354	VT-8110 MONTAŽNI KIT S DIFUZOROM ZA LED TRAKU POVRŠINE 2000X17.2X14.44MM SREBRNA
3355	VT-8113 MONTAŽNI KIT S DIFUZOROM ZA LED TRAKU POVRŠINE 2000X17.4X7MM SREBRNA
3356	VT-8114 MONTAŽNI KIT S DIFUZOROM ZA KUTNU LED TRAKU 2000X19X19MM SREBRNA
3357	VT-8115 PRIBOR ZA MONTAŽU S DIFUZOROM ZA LED TRAKU UDUBLJENU 2000X24.5X12.2MM SREBRNA
3358	VT-8116 GARNITURA ZA MONTAŽU S DIFUZOROM ZA POVRŠINSKU LED TRAKU 2000X17.4X12.1MM SREBRNA
3359	VT-8101 MONTAŽNI KIT S DIFUZOROM ZA LED TRAKU UDUBLJENU 2000x61.5x14MM SREBRNA
3360	VT-8102 MONTAŽNI KIT S DIFUZOROM ZA LED TRAKU UDUBLJENU 2000x52.1x13.3MM SREBRNA
3361	VT-8103 PRIBOR ZA MONTAŽU S DIFUZOROM ZA LED TRAKU 2000x50.12x22.34MM SREBRNA
3362	VT-8104 MONTAŽNI KIT S DIFUZOROM ZA LED TRAKU UDUBLJENU 2000x45.4x25.14MM SREBRNA
3363	VT-8105 MONTAŽNI KIT S DIFUZOROM ZA KUTNU LED TRAKU 2000x20.3x30MM SREBRNA
3364	VT-8114-W MONTAŽNI KIT S DIFUZOROM ZA LED TRAKU PCB 12MM KUT 2000X19X19MM BIJELA
3365	VT-8113-W MONTAŽNI KIT S DIFUZOROM ZA LED TRAKU PCB 12MM POVRŠINA 2000X17.4X7MM BIJELA
3366	VT-8110-W MONTAŽNI KIT S DIFUZOROM ZA LED TRAKU PCB 20MM POVRŠINA 2000X17.2X14.44MM BIJELA
3367	VT-8108-W MONTAŽNI KIT S DIFUZOROM ZA LED TRAKU PCB 20MM POVRŠINA 2000X23.5X10.4MM BIJELA
3368	VT-8122 MONTAŽNI KIT S DIFUZOROM ZA LED TRAKU PCB 12MM UDUBLJENA 2000X24.7X7MM BIJELA
3369	VT-8123 MONTAŽNI KIT S DIFUZOROM ZA LED TRAKU PCB 12MM KUT 2000X15.8X15.8MM BIJELA
3370	VT-9327 MONTAŽNI KIT S DIFUZOROM ZA POVRŠINSKU LED TRAKU 2000X15.55X5.9MM SREBRNA
3371	VT-8118 MONTAŽNI KIT S DIFUZOROM ZA LED TRAKU POVRŠINE 2000X30X20MM SREBRNA
3372	VT-8119 PRIBOR ZA MONTAŽU S DIFUZOROM ZA LED TRAKU UDUBLJENU 2000X30X20MM SREBRNA

9956	VT-7104 PRIBOR ZA MONTAŽU S DIFUZOROM ZA KUTNU LED TRAKU 2000MM SREBRNA (PAKIRANJE 2KOM.)
2610	VT-8117 PRIBOR ZA MONTAŽU S DIFUZOROM ZA POVRŠINU LED TRAKE 2000MM NEON FLEX
2871	VT-8126 PRIBOR ZA MONTAŽU S DIFUZOROM ZA LED TRAKU UDUBLJENU 2000x50x35mm BIJELA
2872	VT-8127 GARNITURA ZA MONTAŽU SA DIFUZOROM ZA LED TRAKU OBLOŽENA 2000x50x75mm BIJELA
2873	VT-8113 MONTAŽNI KIT S DIFUZOROM ZA LED TRAKU 2000x17,4x7mm CRNI
2874	VT-8109 MONTAŽNI KIT S DIFUZOROM ZA LED TRAKU 2000x15.8x15.8mm CRNI
2875	VT-8106 MONTAŽNI KIT S DIFUZOROM ZA LED TRAKU 2000x24,7x7mm CRNI
2876	VT-8108 MONTAŽNI KIT S DIFUZOROM ZA LED TRAKU 2000x23,5x10mm CRNI
2877	VT-8114 PRIBOR ZA MONTAŽU SA DIFUZOROM ZA LED TRAKU 2000x19x19mm CRNI
2878	VT-8110 PRIBOR ZA MONTAŽU SA DIFUZOROM ZA LED TRAKU 2000x17,2x14,4mm CRNI
2903	VT-8136 GARNITURA ZA MONTAŽU S DIFUZOROM ZA LED TRAKU OBLOŽENE 2000MM
2904	VT-8137 PRIBOR ZA MONTAŽU S DIFUZOROM ZA LED TRAKU UDUBLJENU 2000MM
2909	VT-8138 GARNITURA ZA MONTAŽU S DIFUZOROM SAVIJIV ZA LED TRAKU 2000x18x6MM SILVER KUČIŠTE
10320	VT-8156 MONTAŽNI KIT S DIFUZOROM ZA LED TRAKU 2000x24,7x7mm
10321	VT-8157 MONTAŽNI KIT S DIFUZOROM ZA LED TRAKU 2000x17,4x7mm
10322	VT-8158 MONTAŽNI KIT S DIFUZOROM ZA LED TRAKU 2000x15.8mmx15.8mm
23173	VT-8201 MONTAŽNI KIT S DIFUZOROM ZA LED TRAKU 2000x55x15mm SILVER TIJELO
23174	VT-8202 MONTAŽNI KIT S DIFUZOROM ZA LED TRAKU 2000x20x10mm SILVER TIJELO
23175	VT-8203 MONTAŽNI KIT S DIFUZOROM ZA LED TRAKU 2000x20x10mm SILVER TIJELO
23176	VT-8204S MONTAŽNI KIT S DIFUZOROM ZA LED TRAKU 2000x30x10mm SREBRNO TIJELO
23177	VT-8204 MONTAŽNI KIT S DIFUZOROM ZA LED TRAKU 2000x30x10mm SILVER TIJELO
23178	VT-8206S MONTAŽNI KIT S DIFUZOROM ZA LED TRAKU 2000x50x20mm SILVER TIJELO
23179	VT-8206 MONTAŽNI KIT S DIFUZOROM ZA LED TRAKU 2000x50x20mm SILVER TIJELO
23180	VT-8208 MONTAŽNI KIT S DIFUZOROM ZA LED TRAKU 2000x60x36mm SILVER TIJELO

NÁVOD K POUŽITÍ

HLINÍKOVÝ PROFIL

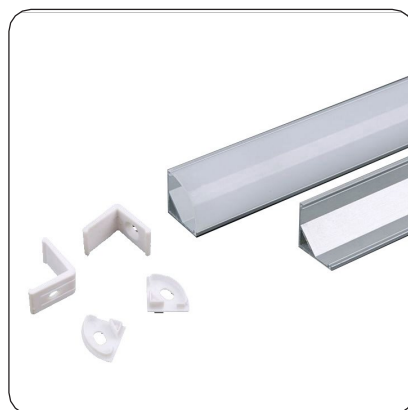

02 METER
LENGTH

ÚVOD

Děkujeme, že jste si vybrali a zakoupili produkt V-TAC. V-TAC vám bude sloužit co nejlépe. Před zahájením instalace si pečlivě přečtěte tento návod a uschovejte jej pro budoucí použití. V případě jakýchkoli dalších dotazů se obraťte na našeho prodejce nebo místního prodejce, od kterého jste výrobek zakoupili. Jsou vyškoleni a připraveni vám co nejlépe posloužit.

ÚDRŽBA

- **Opatření před čištěním:** Před čištěním výrobku se ujistěte, že je odpojen od elektrické sítě. Jedná se o zásadní bezpečnostní opatření, které zabrání jakýmkoli elektrickým nehodám.
- **Postup čištění:** K čištění rámu použijte bavlněný hadřík lehce navlhčený alkoholem. Zdržte se s použitím silných chemických látek. Je nutné zajistit, aby se kapalina nedostala do kontaktu s elektrickými součástmi výrobku.
- **Bezpečnostní opatření:** Úklid by neměly provádět děti mladší 8 let, ledaže by byly mladší 8 let. dohled dospělé osoby. Je to z důvodu zajištění bezpečnosti dítěte a správného zacházení s výrobkem.
- **Řezání profilu:** Zajistěte hliníkový profil na místě pomocí svěráku nebo svorek, aby se při řezání nepohyboval. Dbejte na to, aby byl řez co nejrovnější, aby se co nejlépe přizpůsobil.
- **Vyhlazení okrajů:** Hrany hliníkového profilu mohou být po řezání ostré nebo nerovné. Pomocí pilníku vyhladte je a dbejte na odstranění kovových otřepů, které by mohly způsobit poškození.



Toto označení znamená, že tento výrobek by neměl být likvidován společně s ostatními odpady z domácnosti.

NÁVOD K INSTALACI ZAPUŠTĚNÉ

INSTALACE

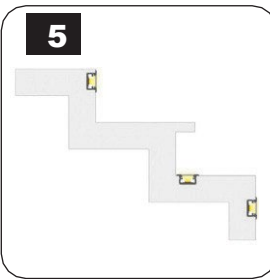
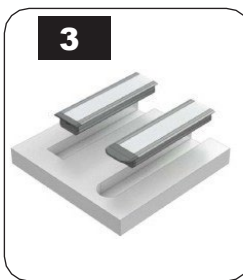
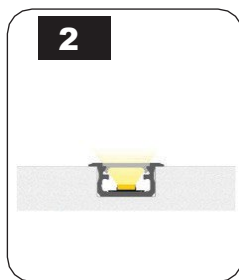
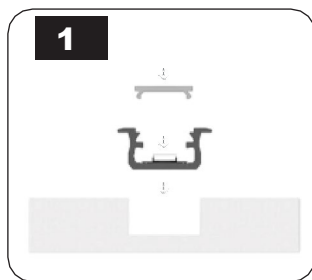

POVRCHOVÁ INSTALACE

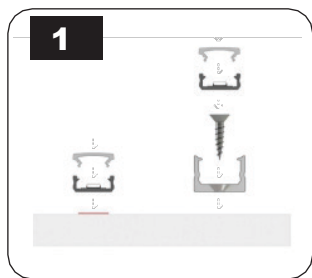

INSTALACE SÁDRY

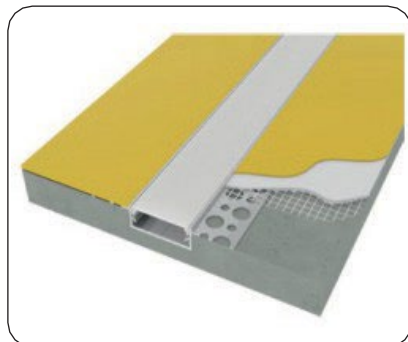

ROHOVÁ INSTALACE

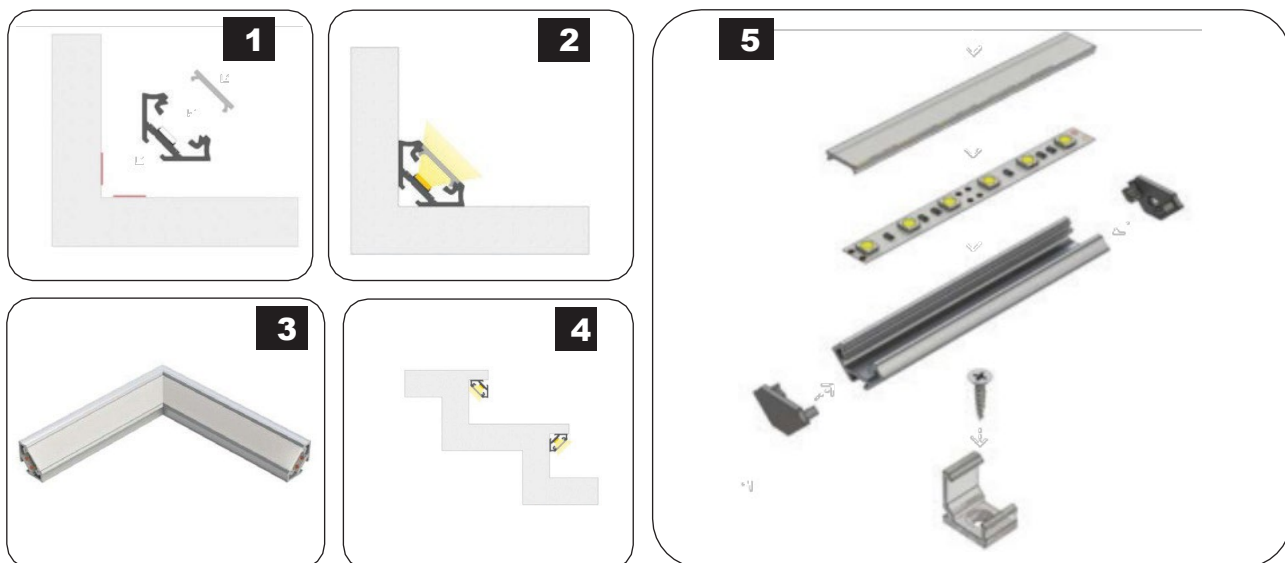

POPISY PRODUKTŮ

SKU	POPIS
3350	VT-8106 MONTÁŽNÍ SADA S DIFUZOREM PRO LED PÁSKY ZAPUŠTĚNÉ 2000X24.7X7MM STŘÍBRNÁ
3351	VT-8107 MONTÁŽNÍ SADA S DIFUZOREM PRO LED PÁSKY ZAPUŠTĚNÉ 2000X24X14,2MM STŘÍBRNÁ
3352	VT-8108 MONTÁŽNÍ SADA S DIFUZÉREM PRO POVRCHOVÉ LED PÁSKY 2000X23,5X10MM STŘÍBRNÁ
3353	VT-8109 MONTÁŽNÍ SADA S DIFUZOREM PRO LED PÁSKY ROHOVÉ 2000X15.8X15.8MM STŘÍBRNÁ
3354	VT-8110 MONTÁŽNÍ SADA S DIFUZÉREM PRO POVRCHOVÉ LED PÁSKY 2000X17.2X14.44MM STŘÍBRNÁ
3355	VT-8113 MONTÁŽNÍ SADA S DIFUZÉREM PRO POVRCHOVOU LED PÁSKU 2000X17.4X7MM STŘÍBRNÁ
3356	VT-8114 MONTÁŽNÍ SADA S DIFUZOREM PRO LED PÁSKY ROHOVÉ 2000X19X19MM STŘÍBRNÁ
3357	VT-8115 MONTÁŽNÍ SADA S DIFUZOREM PRO LED PÁSKY ZAPUŠTĚNÉ 2000X24.5X12.2MM STŘÍBRNÁ
3358	VT-8116 MONTÁŽNÍ SADA S DIFUZOREM PRO POVRCHOVÉ LED PÁSKY 2000X17.4X12.1MM STŘÍBRNÁ
3359	VT-8101 MONTÁŽNÍ SOUPRAVA S DIFUSEREM PRO LED STRIP RECESSED 2000x61,5x14MM STŘÍBRNÁ
3360	VT-8102 MONTÁŽNÍ SOUPRAVA S DIFUSEREM PRO LED STRIP RECESSED 2000x52.1x13.3MM STŘÍBRNÁ
3361	VT-8103 MONTÁŽNÍ SADA S DIFUSEREM PRO LED STRIP 2000x50.12x22.34MM STŘÍBRNÁ
3362	VT-8104 MONTÁŽNÍ SOUPRAVA S DIFUSEREM PRO LED STRIP RECESSED 2000x45.4x25.14MM STŘÍBRNÁ
3363	VT-8105 MONTÁŽNÍ SADA S DIFUSÁTOREM PRO LED STRIP CORNER 2000x20.3x30MM STŘÍBRNÁ
3364	VT-8114-W MONTÁŽNÍ SADA S DIFUZOREM PRO LED PÁSKY NA DESKY 12MM ROHOVÉ 2000X19X19MM BÍLÁ
3365	VT-8113-W MONTÁŽNÍ SADA S DIFUZOREM PRO LED PÁSKY NA DESKY PLOŠNÝCH SPOJŮ 12MM POVRCH 2000X17.4X7MM BÍLÁ
3366	VT-8110-W MONTÁŽNÍ SADA S DIFUZOREM PRO LED PÁSKY NA DESKY PLOŠNÝCH SPOJŮ 20MM POVRCH 2000X17.2X14.44MM BÍLÁ
3367	VT-8108-W MONTÁŽNÍ SADA S DIFUZOREM PRO LED PÁSKY NA DESKY PLOŠNÝCH SPOJŮ 20MM POVRCH 2000X23.5X10.4MM BÍLÁ
3368	VT-8122 MONTÁŽNÍ SADA S DIFUZOREM PRO LED PÁSKY NA DESKY 12MM ZAPUŠTĚNÉ 2000X24.7X7MM BÍLÁ
3369	VT-8123 MONTÁŽNÍ SADA S DIFUZÉREM PRO LED PÁSKOVÉ DESKY 12MM ROH 2000X15.8X15.8MM BÍLÁ
3370	VT-9327 MONTÁŽNÍ SADA S DIFUZÉREM PRO POVRCHOVÉ LED PÁSKY 2000X15.55X5.9MM STŘÍBRNÁ
3371	VT-8118 MONTÁŽNÍ SADA S DIFUZÉREM PRO POVRCHOVÉ LED PÁSKY 2000X30X20MM STŘÍBRNÁ
3372	VT-8119 MONTÁŽNÍ SADA S DIFUZOREM PRO LED PÁSKY ZAPUŠTĚNÉ 2000X30X20MM STŘÍBRNÁ

9956	VT-7104 MONTÁŽNÍ SADA S DIFUZOREM PRO LED PÁSKY ROHOVÉ 2000MM STŘÍBRNÁ (2KS BALENÍ)
2610	VT-8117 MONTÁŽNÍ SADA S DIFUZOREM PRO LED PÁSEK POVRCH 2000MM NEON FLEX
2871	VT-8126 MONTÁŽNÍ SOUPRAVA S ROZDĚLOVAČEM PRO LED STRIP RECESSED 2000x50x35mm BÍLÁ
2872	VT-8127 MONTÁŽNÍ SOUPRAVA S ROZDĚLOVAČEM PRO LED STRIP SURFACED 2000x50x75mm BÍLÁ
2873	VT-8113 MONTÁŽNÍ SADA S DIFUSEREM PRO LED STRIP 2000x17,4x7mm ČERNÁ
2874	VT-8109 MONTÁŽNÍ SADA S DIFUSEREM PRO LED STRIP 2000x15,8x15,8mm ČERNÁ
2875	VT-8106 MONTÁŽNÍ SADA S DIFUSEREM PRO LED STRIP 2000x24,7x7mm ČERNÁ
2876	VT-8108 MONTÁŽNÍ SADA S DIFUSEREM PRO LED STRIP 2000x23,5x10mm ČERNÁ
2877	VT-8114 MONTÁŽNÍ SADA S DIFUSEREM PRO LED STRIP 2000x19x19mm ČERNÁ
2878	VT-8110 MONTÁŽNÍ SADA S DIFUSEREM PRO LED STRIP 2000x17,2x14,4mm ČERNÁ
2903	VT-8136 MONTÁŽNÍ SADA S DIFUZOREM PRO LED PÁSKY S POVRCHOVOU ÚPRAVOU 2000 MM
2904	VT-8137 MONTÁŽNÍ SADA S DIFUZOREM PRO LED PÁSKY ZAPUŠTĚNÉ 2000MM
2909	VT-8138 MONTÁŽNÍ SOUPRAVA S DIFUSÁTOREM OHÝBANÝM PRO LED STRIP 2000x18x6MM STŘÍBRNÉ KABELKY
10320	VT-8156 MONTÁŽNÍ SADA S ROZDĚLOVAČEM PRO LED STRIP 2000x24,7x7mm
10321	VT-8157 MONTÁŽNÍ SADA S ROZDĚLOVAČEM PRO LED STRIP 2000x17,4x7mm
10322	VT-8158 MONTÁŽNÍ SADA S ROZDĚLOVAČEM PRO LED STRIP 2000x15,8mmx15,8mm
23173	VT-8201 MONTÁŽNÍ SOUPRAVA S DIFUSEREM PRO LED STRIP 2000x55x15mm STŘÍBRNÉ TĚLO
23174	VT-8202 MONTÁŽNÍ SADA S DIFUSÁTOREM PRO LED STRIP 2000x20x10mm STŘÍBRNÉ TĚLO
23175	VT-8203 MONTÁŽNÍ SOUPRAVA S DIFUSEREM PRO LED STRIP 2000x20x10mm STŘÍBRNÉ TĚLO
23176	VT-8204S MONTÁŽNÍ SADA S ROZDĚLOVAČEM PRO LED STRIP 2000x30x10mm STŘÍBRNÉ TĚLO
23177	VT-8204 MONTÁŽNÍ SADA S DIFUSEREM PRO LED STRIP 2000x30x10mm STŘÍBRNÉ TĚLO
23178	VT-8206S MONTÁŽNÍ SOUPRAVA S DIFUSEREM PRO LED STRIP 2000x50x20mm STŘÍBRNÉ TĚLO
23179	VT-8206 MONTÁŽNÍ SOUPRAVA S DIFUSEREM PRO LED STRIP 2000x50x20mm STŘÍBRNÉ TĚLO
23180	VT-8208 MONTÁŽNÍ SOUPRAVA S DIFUSEREM PRO LED STRIP 2000x60x36mm STŘÍBRNÉ TĚLO



Meaningful Innovation.

WEEE Number: 80133970

MANUEL D'INSTRUCTIONS

PROFILÉ EN ALUMINIUM

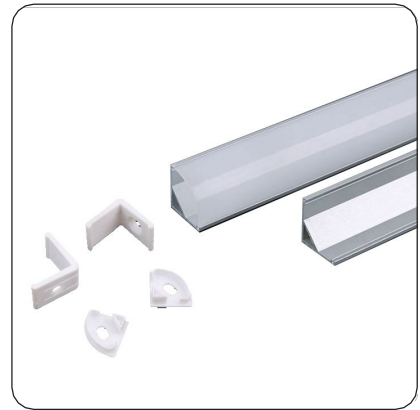

02 METER
LENGTH

INTRODUCTION

Merci d'avoir choisi et acheté un produit V-TAC. V-TAC vous servira au mieux. Veuillez lire attentivement ces instructions avant de commencer l'installation et conservez ce manuel à portée de main pour pouvoir vous y référer ultérieurement. Si vous avez d'autres questions, veuillez contacter notre revendeur ou le vendeur local auprès duquel vous avez acheté le produit. Ils sont formés et prêts à vous servir au mieux.

ENTRETIEN

- **Précautions à prendre avant le nettoyage :** Avant de nettoyer le produit, assurez-vous qu'il est déconnecté de la tension secteur. Il s'agit d'une mesure de sécurité essentielle pour éviter tout accident électrique.
- **Procédure de nettoyage :** Utilisez un chiffon en coton légèrement imbibé d'alcool pour nettoyer le cadre. Ne pas utiliser de produits utilisant des agents chimiques puissants. Il est impératif de veiller à ce que le liquide n'entre pas en contact avec les composants électriques du produit.
- **Mesures de sécurité :** Le nettoyage ne doit pas être effectué par des enfants de moins de 8 ans, à moins qu'ils ne soient sous l'emprise de la loi sur la protection de l'environnement. la surveillance d'un adulte. Ceci afin de garantir la sécurité de l'enfant et la bonne manipulation du produit.
- **Découpe du profilé :** Fixez le profilé en aluminium à l'aide d'un étau ou de serre-joints afin qu'il ne bouge pas pendant la découpe. Veillez à ce que la coupe soit aussi droite que possible pour obtenir le meilleur ajustement possible.
- **Lisser les bords :** Après la découpe, les bords du profilé en aluminium peuvent être coupants ou irréguliers. Utilisez une lime pour les lisser, en prenant soin d'éliminer toute bavure métallique susceptible de causer des dommages.



Ce marquage indique que ce produit ne doit pas être éliminé avec les autres déchets ménagers.

N CAS DE QUESTION/PROBLÈME CONCERNANT LE PRODUIT, VEUILLEZ NOUS CONTACTER À L'ADRESSE SUIVANTE : SUPPORT@V-TAC.EU. POUR PLUS D'INFORMATIONS SUR LA GAMME DE PRODUITS, VEUILLEZ CONTACTER NOTRE DISTRIBUTEUR OU LES REVENDEURS LES PLUS PROCHES.

V-TAC EUROPE LTD. BULGARIA, PLOVDIV 4000, BUL.L.KARAVELOW 9B

INSTRUCTIONS D'INSTALLATION

INSTALLATION ENCASTRÉE

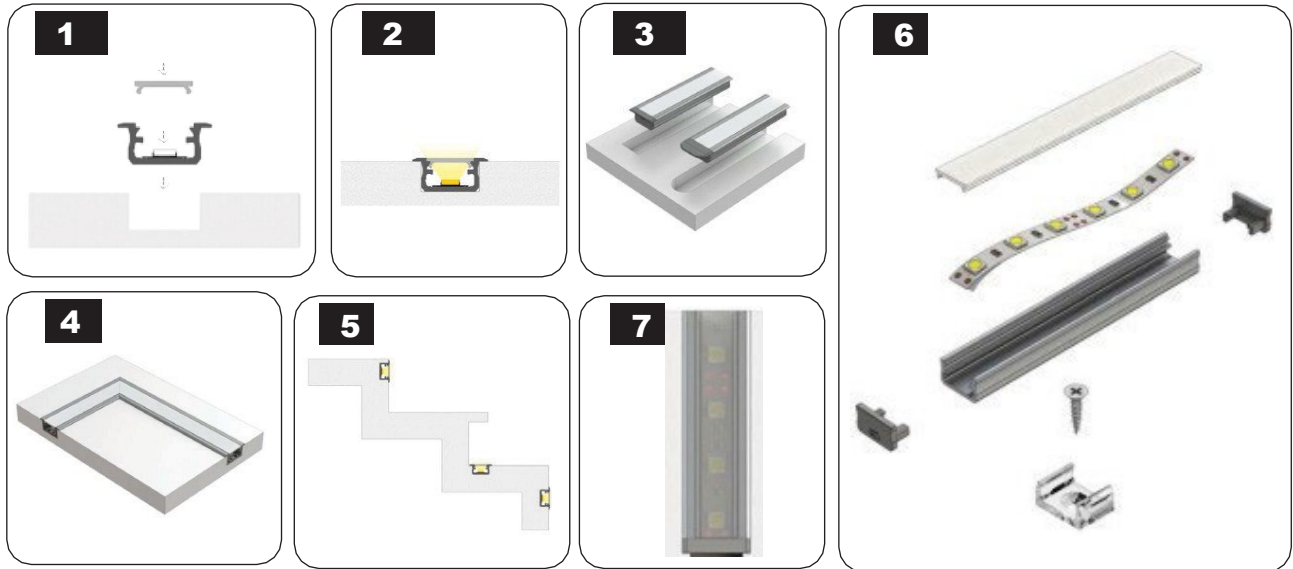

INSTALLATION EN SURFACE



INSTALLATION DE GYPSE

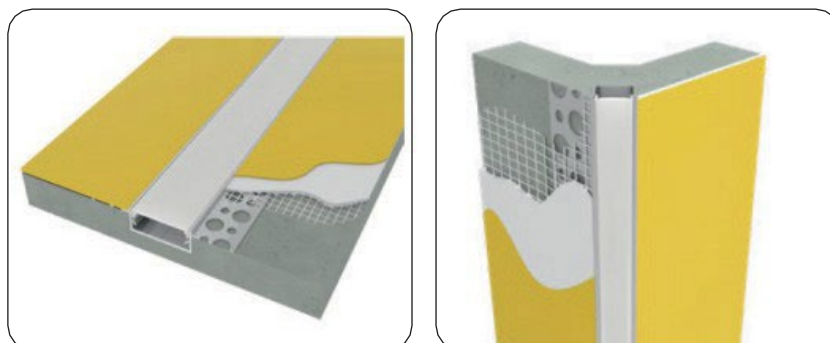

INSTALLATION EN ANGLE

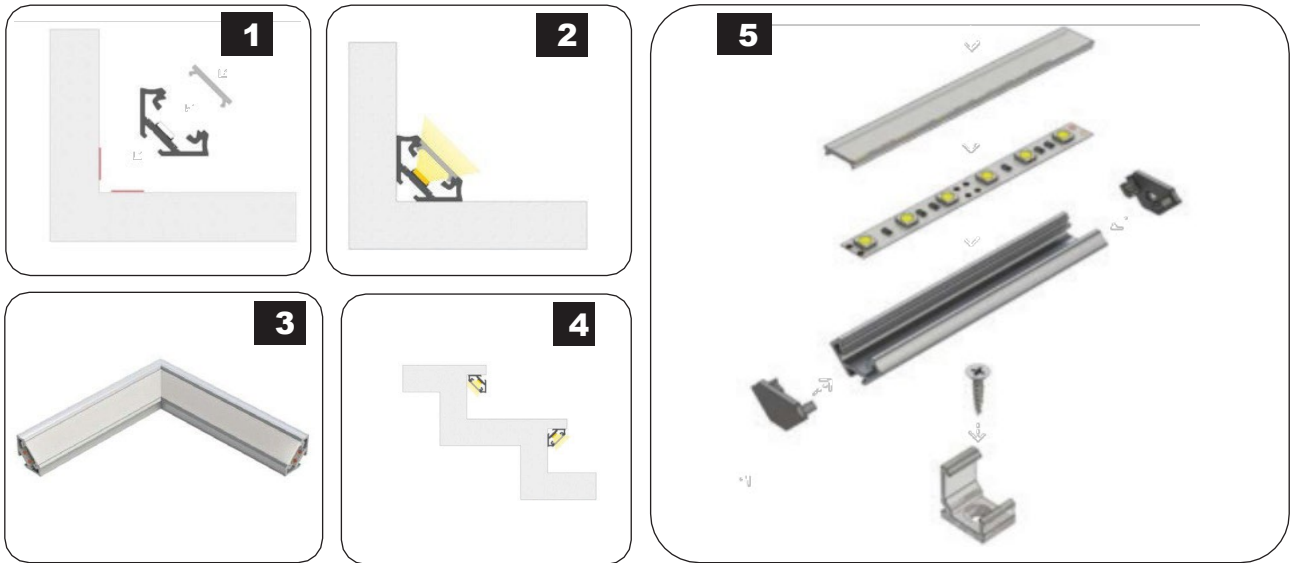

DESCRIPTIONS DES PRODUITS

SKU	DESCRIPTION
3350	VT-8106 KIT DE MONTAGE AVEC DIFFUSEUR POUR BANDE LED ENCASTRÉE 2000X24,7X7MM ARGENT
3351	VT-8107 KIT DE MONTAGE AVEC DIFFUSEUR POUR BANDE LED ENCASTRÉE 2000X24X14.2MM ARGENT
3352	VT-8108 KIT DE MONTAGE AVEC DIFFUSEUR POUR BANDE LED SURFACE 2000X23,5X10MM ARGENT
3353	VT-8109 KIT DE MONTAGE AVEC DIFFUSEUR POUR LED STRIP CORNER 2000X15.8X15.8MM ARGENTÉ
3354	VT-8110 KIT DE MONTAGE AVEC DIFFUSEUR POUR BANDE LED SURFACE 2000X17.2X14.44MM ARGENTÉ
3355	VT-8113 KIT DE MONTAGE AVEC DIFFUSEUR POUR BANDE LED SURFACE 2000X17.4X7MM ARGENT
3356	VT-8114 KIT DE MONTAGE AVEC DIFFUSEUR POUR BANDE LED CORNER 2000X19X19MM ARGENTÉ
3357	VT-8115 KIT DE MONTAGE AVEC DIFFUSEUR POUR BANDE LED ENCASTRÉE 2000X24.5X12.2MM ARGENT
3358	VT-8116 KIT DE MONTAGE AVEC DIFFUSEUR POUR BANDE LED SURFACE 2000X17.4X12.1MM ARGENTÉ
3359	VT-8101 KIT DE MONTAGE AVEC DIFFUSEUR POUR BANDE LED RECESSÉE 2000x61,5x14MM ARGENT
3360	VT-8102 KIT DE MONTAGE AVEC DIFFUSEUR POUR BANDE LED RECESSÉE 2000x52,1x13,3MM ARGENT
3361	VT-8103 KIT DE MONTAGE AVEC DIFFUSEUR POUR BANDE LED 2000x50.12x22.34MM ARGENT
3362	VT-8104 KIT DE MONTAGE AVEC DIFFUSEUR POUR BANDE LED RECESSÉE 2000x45.4x25.14MM ARGENT
3363	VT-8105 KIT DE MONTAGE AVEC DIFFUSEUR POUR PANNEAU DE LED 2000x20.3x30MM ARGENT
3364	VT-8114-W KIT DE MONTAGE AVEC DIFFUSEUR POUR BANDE LED PCB 12MM CORNER 2000X19X19MM BLANC
3365	VT-8113-W KIT DE MONTAGE AVEC DIFFUSEUR POUR BANDE LED PCB 12MM SURFACE 2000X17.4X7MM BLANC
3366	VT-8110-W KIT DE MONTAGE AVEC DIFFUSEUR POUR BANDE LED PCB 20MM SURFACE 2000X17.2X14.44MM BLANC
3367	VT-8108-W KIT DE MONTAGE AVEC DIFFUSEUR POUR BANDE LED PCB 20MM SURFACE 2000X23.5X10.4MM BLANC
3368	VT-8122 KIT DE MONTAGE AVEC DIFFUSEUR POUR BANDE LED PCB 12MM ENCASTRÉE 2000X24.7X7MM BLANC
3369	VT-8123 KIT DE MONTAGE AVEC DIFFUSEUR POUR BANDE LED PCB 12MM ANGLE 2000X15.8X15.8MM BLANC
3370	VT-9327 KIT DE MONTAGE AVEC DIFFUSEUR POUR BANDE LED SURFACE 2000X15.55X5.9MM ARGENT
3371	VT-8118 KIT DE MONTAGE AVEC DIFFUSEUR POUR BANDE LED SURFACE 2000X30X20MM ARGENTÉ
3372	VT-8119 KIT DE MONTAGE AVEC DIFFUSEUR POUR BANDE LED ENCASTRÉE 2000X30X20MM ARGENTÉ

9956	VT-7104 KIT DE MONTAGE AVEC DIFFUSEUR POUR BANDE LED CORNER 2000MM ARGENT (PACK DE 2PCS)
2610	VT-8117 KIT DE MONTAGE AVEC DIFFUSEUR POUR BANDE LED SURFACE 2000MM NEON FLEX
2871	VT-8126 KIT DE MONTAGE AVEC DIFFUSEUR POUR BANDE LED RECESSÉE 2000x50x35mm BLANC
2872	VT-8127 KIT DE MONTAGE AVEC DIFFUSEUR POUR BANDE DE LED SURFACE 2000x50x75mm BLANC
2873	VT-8113 KIT DE MONTAGE AVEC DIFFUSEUR POUR BANDE DE LED 2000x17.4x7mm NOIR
2874	VT-8109 KIT DE MONTAGE AVEC DIFFUSEUR POUR BANDE DE LED 2000x15.8x15.8mm NOIR
2875	VT-8106 KIT DE MONTAGE AVEC DIFFUSEUR POUR BANDE DE LED 2000x24,7x7mm NOIR
2876	VT-8108 KIT DE MONTAGE AVEC DIFFUSEUR POUR BANDE DE LED 2000x23.5x10mm NOIR
2877	VT-8114 KIT DE MONTAGE AVEC DIFFUSEUR POUR BANDE DE LED 2000x19x19mm NOIR
2878	VT-8110 KIT DE MONTAGE AVEC DIFFUSEUR POUR BANDE DE LED 2000x17.2x14.4mm NOIR
2903	VT-8136 KIT DE MONTAGE AVEC DIFFUSEUR POUR BANDE LED SURFACEE 2000MM
2904	VT-8137 KIT DE MONTAGE AVEC DIFFUSEUR POUR BANDE LED ENCASTRÉE 2000MM
2909	VT-8138 KIT DE MONTAGE AVEC DIFFUSEUR BENDABLE POUR BANDE LED 2000x18x6MM COFFRET ARGENT
10320	VT-8156 KIT DE MONTAGE AVEC DIFFUSEUR POUR BANDE DE LED 2000x24,7x7mm
10321	VT-8157 KIT DE MONTAGE AVEC DIFFUSEUR POUR BANDE LED 2000x17.4x7mm
10322	VT-8158 KIT DE MONTAGE AVEC DIFFUSEUR POUR BANDE LED 2000x15.8mmx15.8mm
23173	VT-8201 KIT DE MONTAGE AVEC DIFFUSEUR POUR BANDE LED 2000x55x15mm CORPS ARGENT
23174	VT-8202 KIT DE MONTAGE AVEC DIFFUSEUR POUR BANDE LED 2000x20x10mm CORPS ARGENT
23175	VT-8203 KIT DE MONTAGE AVEC DIFFUSEUR POUR BANDE DE LED 2000x20x10mm CORPS ARGENT
23176	VT-8204S KIT DE MONTAGE AVEC DIFFUSEUR POUR BANDE LED 2000x30x10mm CORPS ARGENT
23177	VT-8204 KIT DE MONTAGE AVEC DIFFUSEUR POUR BANDE LED 2000x30x10mm CORPS ARGENT
23178	VT-8206S KIT DE MONTAGE AVEC DIFFUSEUR POUR BANDE LED 2000x50x20mm CORPS ARGENT
23179	VT-8206 KIT DE MONTAGE AVEC DIFFUSEUR POUR BANDE DE LED 2000x50x20mm CORPS ARGENT
23180	VT-8208 KIT DE MONTAGE AVEC DIFFUSEUR POUR BANDE DE LED 2000x60x36mm CORPS ARGENT



Meaningful Innovation.

WEEE Number: 80133970

GEBRAUCHSANWEISUNG

ALUMINIUMPROFIL

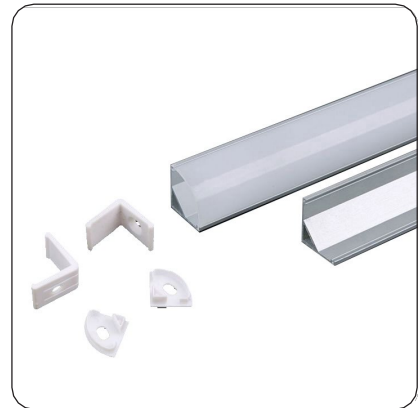

02 METER
LENGTH

EINFÜHRUNG

Vielen Dank, dass Sie ein V-TAC-Produkt ausgewählt und gekauft haben. V-TAC wird Ihnen die besten Dienste leisten. Bitte lesen Sie diese Anleitung sorgfältig durch, bevor Sie mit der Installation beginnen, und bewahren Sie diese Anleitung zum späteren Nachschlagen auf. Sollten Sie weitere Fragen haben, wenden Sie sich bitte an unseren Händler oder an den örtlichen Verkäufer, bei dem Sie das Produkt erworben haben. Sie sind geschult und bereit, Sie bestmöglich zu bedienen.

WARTUNG

- **Vorsichtsmaßnahmen vor der Reinigung:** Stellen Sie vor der Reinigung sicher, dass das Gerät vom Stromnetz getrennt ist. Dies ist eine wichtige Sicherheitsmaßnahme, um elektrische Missgeschicke zu vermeiden.
- **Reinigungsverfahren:** Reinigen Sie den Rahmen mit einem leicht mit Alkohol angefeuchteten Baumwolltuch. Unterlassen Sie es mit starken chemischen Mitteln. Es ist unbedingt darauf zu achten, dass die Flüssigkeit nicht mit den elektrischen Bauteilen des Produkts in Berührung kommt.
- **Sicherheitsmaßnahmen:** Die Reinigung sollte nicht von Kindern unter 8 Jahren durchgeführt werden, es sei denn, sie sind unter Beaufsichtigung durch einen Erwachsenen. Dies dient der Sicherheit des Kindes und der ordnungsgemäßen Handhabung des Produkts.
- **Schneiden des Profils:** Sichern Sie das Aluminiumprofil mit einem Schraubstock oder einer Schraubzwinde, damit es sich beim Schneiden nicht verschiebt. Achten Sie darauf, dass der Schnitt so gerade wie möglich ist, um die beste Passform zu erzielen.
- **Glätten Sie die Kanten:** Nach dem Schneiden können die Kanten des Aluminiumprofils scharf oder uneben sein. Verwenden Sie eine Feile, um Glätten Sie diese und achten Sie dabei darauf, alle Metallgrate zu entfernen, die möglicherweise Schäden verursachen könnten.



Diese Kennzeichnung weist darauf hin, dass dieses Produkt nicht mit anderen Haushaltsabfällen entsorgt

BEI FRAGEN/PROBLEMEN MIT DEM PRODUKT WENDEN SIE SICH BITTE AN UNS UNTER: SUPPORT@V-TAC.EU. FÜR WEITERE PRODUKTE UND ANFRAGEN WENDEN SIE SICH BITTE AN UNSEREN VERTRIEBSPARTNER ODER DEN NÄCHSTGELEGENEN HÄNDLER.

V-TAC EUROPE LTD. BULGARIEN, PLOVDIV 4000, BUL.L.KARAVELOW 9B

EINBAUANLEITUNG UNTERPUTZMONTAGE

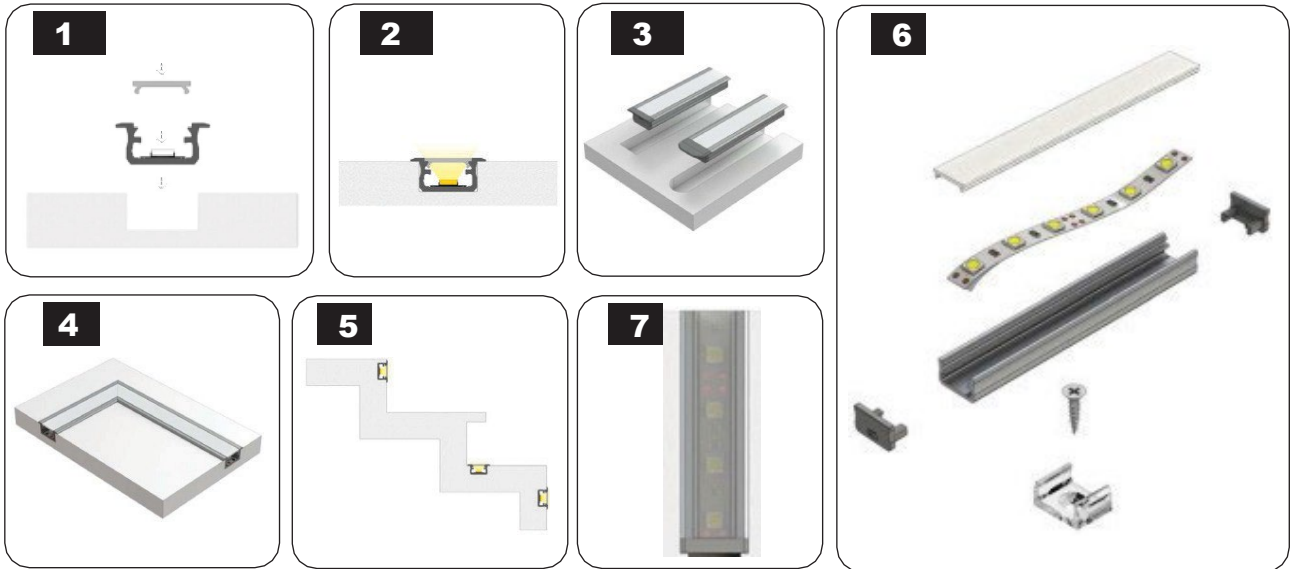

AUFPUTZMONTAGE



GIPSKARTONVERLEGUNG

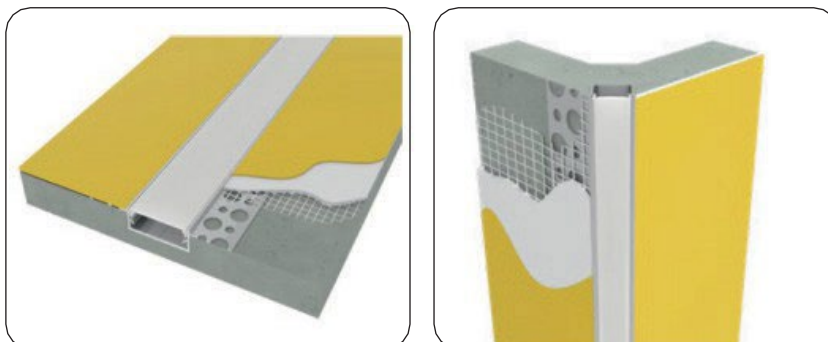

ECKAUFSTELLUNG

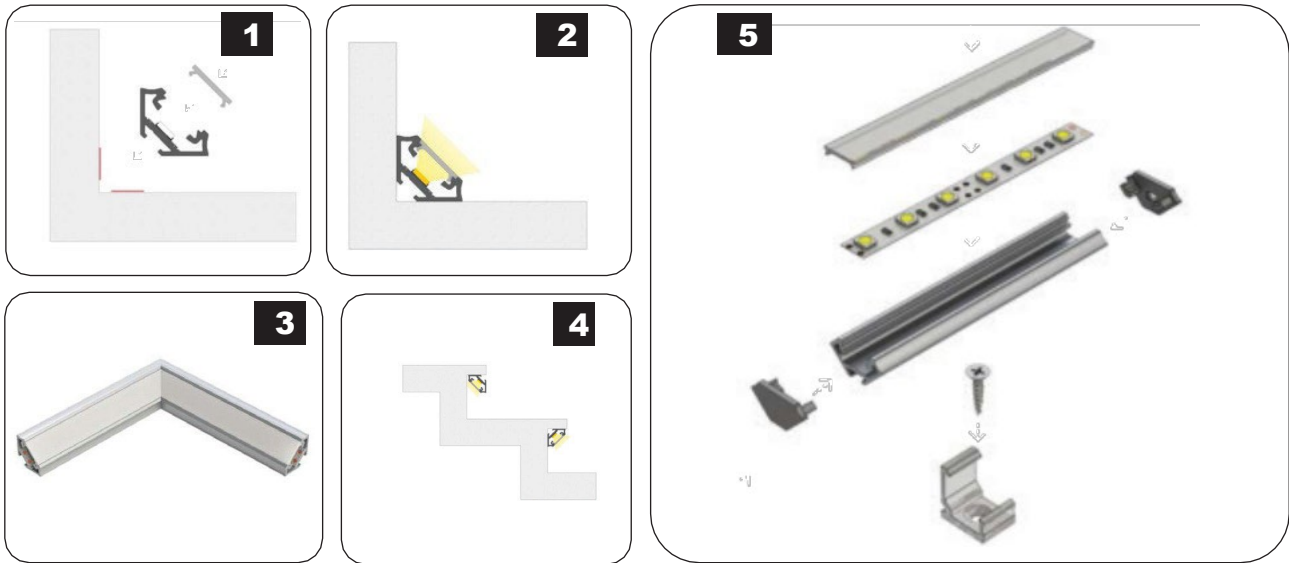

PRODUKTBESCHREIBUNGEN

SKU	BESCHREIBUNG
3350	VT-8106 EINBAUSATZ MIT DIFFUSOR FÜR LED-EINBAUSTREIFEN 2000X24.7X7MM SILBER
3351	VT-8107 EINBAUSATZ MIT DIFFUSOR FÜR LED-EINBAUSTREIFEN 2000X24X14.2MM SILBER
3352	VT-8108 EINBAUSATZ MIT DIFFUSOR FÜR LED STREIFEN OBERFLÄCHE 2000X23.5X10MM SILBER
3353	VT-8109 EINBAUSATZ MIT DIFFUSOR FÜR LED STREIFEN ECKE 2000X15.8X15.8MM SILBER
3354	VT-8110 EINBAUSATZ MIT DIFFUSOR FÜR LED STREIFEN OBERFLÄCHE 2000X17.2X14.44MM SILBER
3355	VT-8113 EINBAUSATZ MIT DIFFUSOR FÜR LED STREIFEN OBERFLÄCHE 2000X17.4X7MM SILBER
3356	VT-8114 EINBAUSATZ MIT DIFFUSOR FÜR LED STREIFEN ECKE 2000X19X19MM SILBER
3357	VT-8115 EINBAUSATZ MIT DIFFUSOR FÜR LED-EINBAUSTREIFEN 2000X24.5X12.2MM SILBER
3358	VT-8116 EINBAUSATZ MIT DIFFUSOR FÜR LED STREIFEN OBERFLÄCHE 2000X17.4X12.1MM SILBER
3359	VT-8101 BEFESTIGUNGSSATZ MIT DIFFUSOR FÜR LED STRIP EINGESETZT 2000x61.5x14MM SILBER
3360	VT-8102 BEFESTIGUNGSSATZ MIT DIFFUSER FÜR LED STRIP EINGESETZT 2000x52.1x13.3MM SILBER
3361	VT-8103 BEFESTIGUNGSSATZ MIT DIFFUSER FÜR LED STRIP 2000x50.12x22.34MM SILBER
3362	VT-8104 BEFESTIGUNGSSATZ MIT DIFFUSOR FÜR LED STRIP EINGESETZT 2000x45.4x25.14MM SILBER
3363	VT-8105 BEFESTIGUNGSSATZ MIT DIFFUSOR FÜR LED STRIP CORNER 2000x20.3x30MM SILBER
3364	VT-8114-W EINBAUSATZ MIT DIFFUSOR FÜR LED STREIFEN PLATINE 12MM ECKE 2000X19X19MM WEISS
3365	VT-8113-W EINBAUSATZ MIT DIFFUSOR FÜR LED STREIFEN PLATINE 12MM OBERFLÄCHE 2000X17.4X7MM WEISS
3366	VT-8110-W EINBAUSATZ MIT DIFFUSOR FÜR LED STREIFEN LEITERPLATTE 20MM OBERFLÄCHE 2000X17.2X14.44MM WEISS
3367	VT-8108-W EINBAUSATZ MIT DIFFUSOR FÜR LED STREIFEN LEITERPLATTE 20MM OBERFLÄCHE 2000X23.5X10.4MM WEISS
3368	VT-8122 EINBAUSATZ MIT DIFFUSOR FÜR LED STREIFEN LEITERPLATTE 12MM VERTIEFT 2000X24.7X7MM WEISS
3369	VT-8123 EINBAUSATZ MIT DIFFUSOR FÜR LED STREIFEN PLATINE 12MM ECKE 2000X15.8X15.8MM WEISS
3370	VT-9327 EINBAUSATZ MIT DIFFUSOR FÜR LED STREIFEN OBERFLÄCHE 2000X15.55X5.9MM SILBER
3371	VT-8118 EINBAUSATZ MIT DIFFUSOR FÜR LED STREIFEN OBERFLÄCHE 2000X30X20MM SILBER
3372	VT-8119 EINBAUSATZ MIT DIFFUSOR FÜR LED-EINBAUSTREIFEN 2000X30X20MM SILBER

9956	VT-7104 MONTAGESATZ MIT DIFFUSOR FÜR LED STREIFEN ECKE 2000MM SILBER(2PCS PACK)
2610	VT-8117 MONTAGESATZ MIT DIFFUSOR FÜR LED STREIFEN OBERFLÄCHE 2000MM NEON FLEX
2871	VT-8126 BEFESTIGUNGSSATZ MIT DIFFUSER FÜR LED STRIP EINGESETZT 2000x50x35mm WEISS
2872	VT-8127 BEFESTIGUNGSSATZ MIT DIFFUSER FÜR LED STRIP OBERFLÄCHE 2000x50x75mm WEISS
2873	VT-8113 MONTAGEKIT MIT DIFFUSER FÜR LED STRIP 2000x17.4x7mm SCHWARZ
2874	VT-8109 MONTAGEKIT MIT DIFFUSER FÜR LED STRIP 2000x15.8x15.8mm SCHWARZ
2875	VT-8106 MONTAGEKIT MIT DIFFUSER FÜR LED STRIP 2000x24.7x7mm SCHWARZ
2876	VT-8108 MONTAGEKIT MIT DIFFUSER FÜR LED STRIP 2000x23.5x10mm SCHWARZ
2877	VT-8114 BEFESTIGUNGSSATZ MIT DIFFUSER FÜR LED STRIP 2000x19x19mm SCHWARZ
2878	VT-8110 MONTAGEKIT MIT DIFFUSER FÜR LED STRIP 2000x17.2x14.4mm SCHWARZ
2903	VT-8136 EINBAUSATZ MIT DIFFUSOR FÜR LED-STREIFEN MIT OBERFLÄCHE 2000MM
2904	VT-8137 EINBAUSATZ MIT DIFFUSOR FÜR LED-EINBAUSTREIFEN 2000MM
2909	VT-8138 BEFESTIGUNGSSATZ MIT DIFFUSER BIEGBAR FÜR LED STRIP 2000x18x6MM SILBERE GEHÄUSE
10320	VT-8156 BEFESTIGUNGSSATZ MIT DIFFUSOR FÜR LED STRIP 2000x24,7x7mm
10321	VT-8157 BEFESTIGUNGSSATZ MIT DIFFUSER FÜR LED STRIP 2000x17.4x7mm
10322	VT-8158 BEFESTIGUNGSSATZ MIT DIFFUSER FÜR LED STRIP 2000x15.8mmx15.8mm
23173	VT-8201 BEFESTIGUNGSSATZ MIT DIFFUSER FÜR LED STRIP 2000x55x15mm SILBERER KÖRPER
23174	VT-8202 BEFESTIGUNGSSATZ MIT DIFFUSER FÜR LED STRIP 2000x20x10mm SILBERNER KÖRPER
23175	VT-8203 BEFESTIGUNGSSATZ MIT DIFFUSER FÜR LED STRIP 2000x20x10mm SILBERNER KÖRPER
23176	VT-8204S BEFESTIGUNGSSATZ MIT DIFFUSER FÜR LED STRIP 2000x30x10mm SILBERNER KÖRPER
23177	VT-8204 BEFESTIGUNGSSATZ MIT DIFFUSER FÜR LED STRIP 2000x30x10mm SILBERNER KÖRPER
23178	VT-8206S BEFESTIGUNGSSATZ MIT DIFFUSER FÜR LED STRIP 2000x50x20mm SILBERE KÖRPER
23179	VT-8206 BEFESTIGUNGSSATZ MIT DIFFUSER FÜR LED STRIP 2000x50x20mm SILBERE KÖRPER
23180	VT-8208 BEFESTIGUNGSSATZ MIT DIFFUSER FÜR LED STRIP 2000x60x36mm SILBERNER KÖRPER

ΕΓΧΕΙΡΙΔΙΟ ΟΔΗΓΙΩΝ

ΠΡΟΦΙΛ ΑΛΟΥΜΙΝΙΟΥ

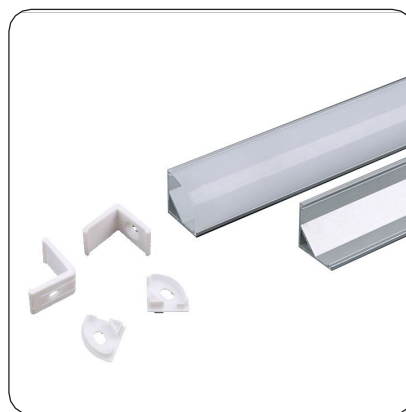

02 METER
LENGTH

ΕΙΣΑΓΩΓΗ

Σας ευχαριστούμε που επιλέξατε και αγοράσατε το προϊόν V-TAC. Η V-TAC θα σας εξυπηρετήσει με τον καλύτερο τρόπο. Παρακαλούμε διαβάστε προσεκτικά αυτές τις οδηγίες πριν ξεκινήσετε την εγκατάσταση και κρατήστε αυτό το εγχειρίδιο πρόχειρο για μελλοντική αναφορά. Εάν έχετε οποιαδήποτε άλλη απορία, παρακαλούμε επικοινωνήστε με τον αντιπρόσωπο μας ή τον τοπικό πωλητή από τον οποίο αγοράσατε το προϊόν. Είναι εκπαιδευμένοι και έτοιμοι να σας εξυπηρετήσουν με τον καλύτερο τρόπο.

ΣΥΝΤΗΡΗΣΗ

- **Προφυλάξεις πριν από τον καθαρισμό:** Πριν από τον καθαρισμό του προϊόντος, βεβαιωθείτε ότι είναι αποσυνδεδεμένο από την τάση δικτύου. Αυτό είναι ένα κρίσιμο μέτρο ασφαλείας για την αποφυγή τυχόν ηλεκτρικών ατυχημάτων.
- **Διαδικασία καθαρισμού:** Χρησιμοποιήστε ένα βαμβακερό πανί ελαφρά βρεγμένο με οινόπνευμα για να καθαρίσετε το πλαίσιο. Αποφύγετε χρησιμοποιώντας ισχυρούς χημικούς παράγοντες. Είναι επιτακτική ανάγκη να διασφαλιστεί ότι το υγρό δεν έρχεται σε επαφή με τα ηλεκτρικά εξαρτήματα του προϊόντος.
- **Μέτρα ασφαλείας:** Καθαρισμός δεν πρέπει να αναλαμβάνεται από παιδιά κάτω των 8 ετών, εκτός εάν είναι κάτω από επίβλεψη από ενήλικα. Αυτό γίνεται για να διασφαλιστεί η ασφάλεια του παιδιού και ο σωστός χειρισμός του προϊόντος.
- **Κοπή του προφίλ:** Ασφαλίστε το προφίλ αλουμινίου στη θέση του χρησιμοποιώντας μια μέγγερη ή σφιγκτήρες για να διασφαλίσετε ότι δεν θα μετακινηθεί κατά την κοπή. Βεβαιωθείτε ότι η κοπή είναι όσο το δυνατόν πιο ευθεία για την καλύτερη εφαρμογή.
- **Εξομαλύνετε τις άκρες:** Μετά την κοπή, οι άκρες του προφίλ αλουμινίου μπορεί να είναι αιχμηρές ή ανομοιόμορφες. Χρησιμοποιήστε μια λίμα για να εξομαλύνετε αυτά, φροντίζοντας να αφαιρέσετε τυχόν μεταλλικά γρέζια που θα μπορούσαν ενδεχομένως να προκαλέσουν βλάβη.



Η σήμανση αυτή υποδεικνύει ότι το προϊόν αυτό δεν πρέπει να απορρίπτεται μαζί με άλλα οικιακά απόβλητα.

ΟΔΗΓΙΕΣ ΕΓΚΑΤΑΣΤΑΣΗΣ ΣΕ ΕΞΟΧΉ

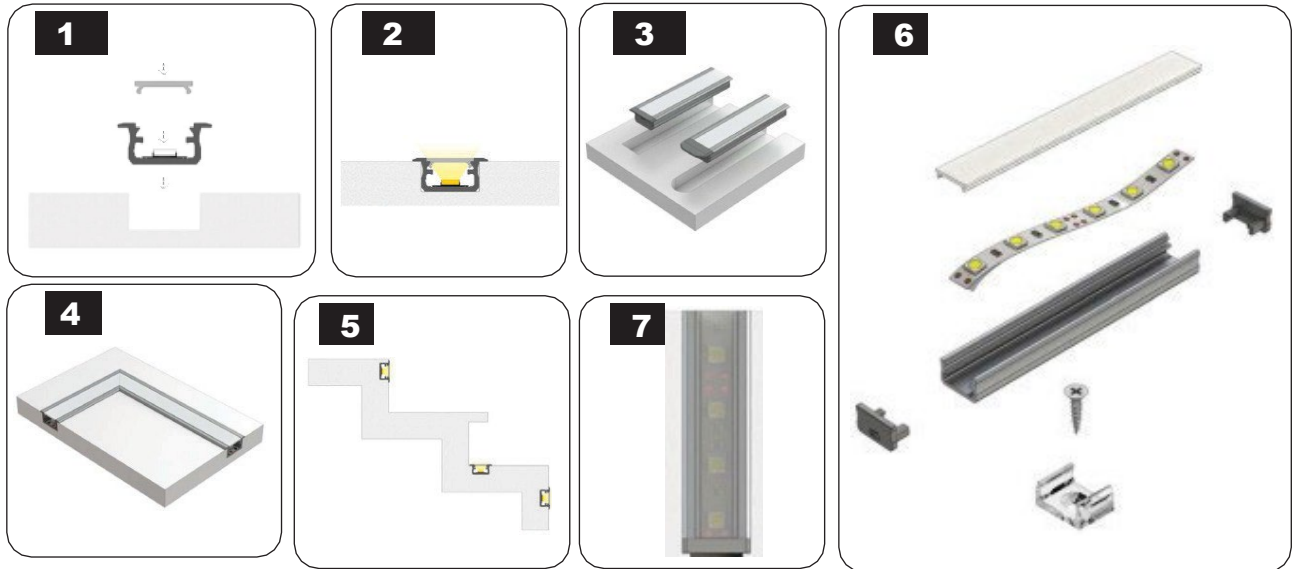

ΕΠΙΦΑΝΕΙΑΚΉ ΕΓΚΑΤΑΣΤΑΣΗ



ΕΓΚΑΤΑΣΤΑΣΗ ΓΥΨΟΥ

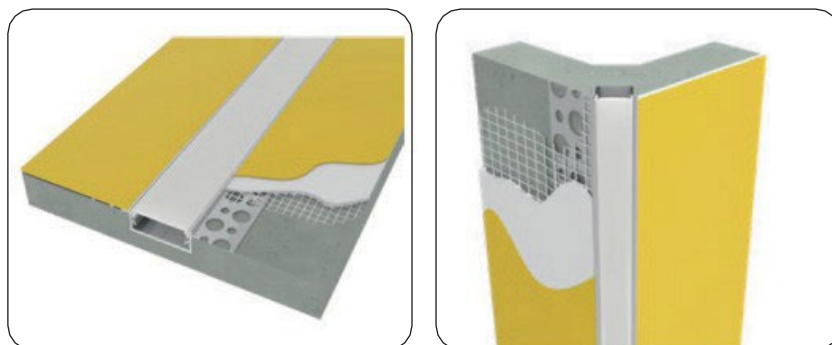

ΓΩΝΙΑΚΉ ΕΓΚΑΤΑΣΤΑΣΗ

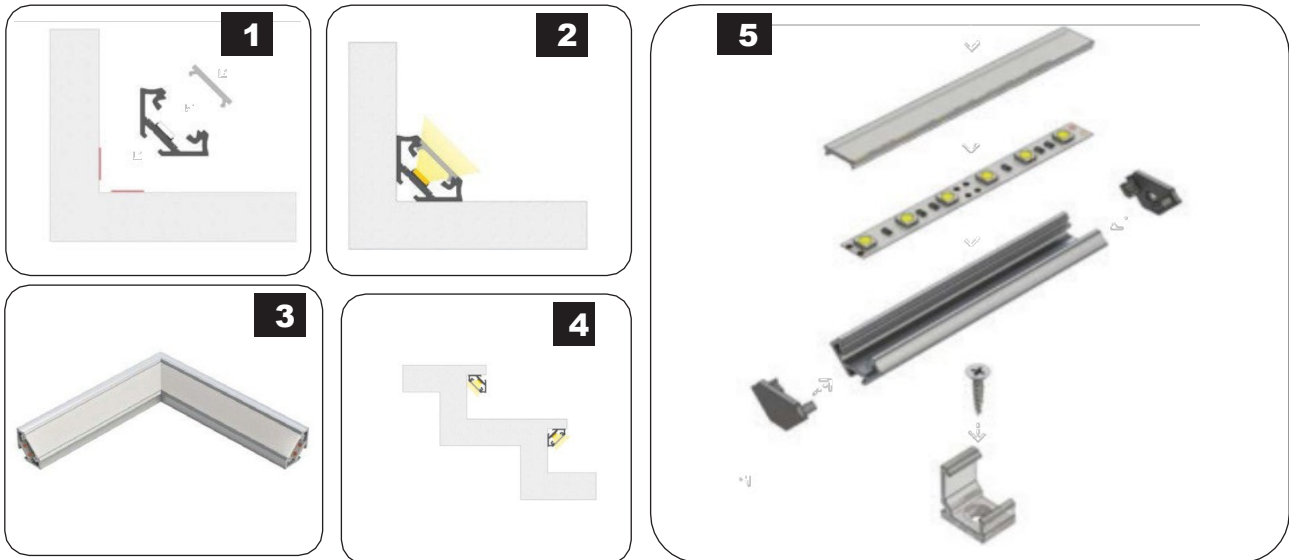

ΠΕΡΙΓΡΑΦΈΣ ΠΡΟΪΟΝΤΩΝ

SKU	ΠΕΡΙΓΡΑΦΗ
3350	VT-8106 ΚΙΤ ΤΟΠΟΘΈΤΗΣΗΣ ΜΕ ΔΙΑΧΥΤΗ ΓΙΑ ΛΩΡΪΔΑ LED ΧΩΝΕΥΤΗ 2000X24.7X7MM ΑΣΗΜΪ
3351	VT-8107 ΚΙΤ ΤΟΠΟΘΈΤΗΣΗΣ ΜΕ ΔΙΑΧΥΤΗ ΓΙΑ ΛΩΡΪΔΑ LED ΧΩΝΕΥΤΗ 2000X24X14.2MM ΑΣΗΜΪ
3352	VT-8108 ΚΙΤ ΤΟΠΟΘΈΤΗΣΗΣ ΜΕ ΔΙΑΧΥΤΗ ΓΙΑ ΕΠΙΦΆΝΕΙΑ ΤΑΙΝΪΑΣ LED 2000X23.5X10MM ΑΣΗΜΪ
3353	VT-8109 ΚΙΤ ΤΟΠΟΘΈΤΗΣΗΣ ΜΕ ΔΙΑΧΥΤΗ ΓΙΑ ΓΩΝΪΑ ΤΑΙΝΪΑΣ LED 2000X15.8X15.8MM ΑΣΗΜΪ
3354	VT-8110 ΚΙΤ ΤΟΠΟΘΈΤΗΣΗΣ ΜΕ ΔΙΑΧΥΤΗ ΓΙΑ ΕΠΙΦΆΝΕΙΑ ΤΑΙΝΪΑΣ LED 2000X17.2X14.44MM ΑΣΗΜΪ
3355	VT-8113 ΚΙΤ ΤΟΠΟΘΈΤΗΣΗΣ ΜΕ ΔΙΑΧΥΤΗ ΓΙΑ ΕΠΙΦΆΝΕΙΑ ΤΑΙΝΪΑΣ LED 2000X17.4X7MM ΑΣΗΜΪ
3356	VT-8114 ΚΙΤ ΤΟΠΟΘΈΤΗΣΗΣ ΜΕ ΔΙΑΧΥΤΗ ΓΙΑ ΓΩΝΪΑ ΤΑΙΝΪΑΣ LED 2000X19X19MM ΑΣΗΜΪ
3357	VT-8115 ΚΙΤ ΤΟΠΟΘΈΤΗΣΗΣ ΜΕ ΔΙΑΧΥΤΗ ΓΙΑ ΛΩΡΪΔΑ LED ΧΩΝΕΥΤΗ 2000X24.5X12.2MM ΑΣΗΜΪ
3358	VT-8116 ΚΙΤ ΤΟΠΟΘΈΤΗΣΗΣ ΜΕ ΔΙΑΧΥΤΗ ΓΙΑ ΕΠΙΦΆΝΕΙΑ ΤΑΙΝΪΑΣ LED 2000X17.4X12.1MM ΑΣΗΜΪ
3359	VT-8101 ΣΕΤ ΣΥΝΑΡΜΟΛΟΓΗΣΗΣ ΜΕ ΑΝΤΪΣΤΡΟΦΗ ΓΙΑ ΛΩΡΪΔΑ LED RECESSED 2000x61.5x14MM ΑΣΗΜΪΝΟ
3360	VT-8102 ΣΕΤ ΣΥΝΑΡΜΟΛΟΓΗΣΗΣ ΜΕ ΑΝΤΪΣΤΡΟΦΗ ΓΙΑ ΛΩΡΪΔΑ LED RECESSED 2000x52.1x13.3MM ΑΣΗΜΪΝΟ
3361	VT-8103 ΣΕΤ ΣΥΝΑΡΜΟΛΟΓΗΣΗΣ ΜΕ ΑΝΤΪΣΤΡΟΦΗ ΓΙΑ ΛΩΡΪΔΑ LED 2000x50.12x22.34MM ΑΣΗΜΪΝΟ
3362	VT-8104 ΣΕΤ ΣΥΝΑΡΜΟΛΟΓΗΣΗΣ ΜΕ ΑΝΤΪΣΤΡΟΦΗ ΓΙΑ ΛΩΡΪΔΑ LED RECESSED 2000x45.4x25.14MM ΑΣΗΜΪΝΟ
3363	VT-8105 ΣΕΤ ΣΥΝΑΡΜΟΛΟΓΗΣΗΣ ΜΕ ΑΝΤΪΣΤΡΟΦΗ ΓΙΑ ΓΩΝΪΑ LED STRIP 2000x20.3x30MM SILVER
3364	VT-8114-W ΚΙΤ ΤΟΠΟΘΈΤΗΣΗΣ ΜΕ ΔΙΑΧΥΤΗ ΓΙΑ ΠΛΑΚΕΤΕΣ LED 12MM ΓΩΝΪΑ 2000X19X19MM ΛΕΥΚΟ
3365	VT-8113-W ΚΙΤ ΤΟΠΟΘΈΤΗΣΗΣ ΜΕ ΔΙΑΧΥΤΗ ΓΙΑ ΠΛΑΚΕΤΕΣ LED 12MM ΕΠΙΦΆΝΕΙΑ 2000X17.4X7MM ΛΕΥΚΟ
3366	VT-8110-W ΚΙΤ ΤΟΠΟΘΈΤΗΣΗΣ ΜΕ ΔΙΑΧΥΤΗ ΓΙΑ ΠΛΑΚΕΤΕΣ LED 20MM ΕΠΙΦΆΝΕΙΑ 2000X17.2X14.44MM ΛΕΥΚΟ
3367	VT-8108-W ΚΙΤ ΤΟΠΟΘΈΤΗΣΗΣ ΜΕ ΔΙΑΧΥΤΗ ΓΙΑ LED STRIP PCB 20MM ΕΠΙΦΆΝΕΙΑ 2000X23.5X10.4MM ΛΕΥΚΟ
3368	VT-8122 ΚΙΤ ΤΟΠΟΘΈΤΗΣΗΣ ΜΕ ΔΙΑΧΥΤΗ ΓΙΑ LED ΛΩΡΪΔΑ PCB 12MM ΕΣΟΧΗ 2000X24.7X7MM ΛΕΥΚΟ
3369	VT-8123 ΚΙΤ ΤΟΠΟΘΈΤΗΣΗΣ ΜΕ ΔΙΑΧΥΤΗ ΓΙΑ LED ΛΩΡΪΔΑ PCB 12MM ΓΩΝΪΑ 2000X15.8X15.8MM ΛΕΥΚΟ
3370	VT-9327 ΚΙΤ ΤΟΠΟΘΈΤΗΣΗΣ ΜΕ ΔΙΑΧΥΤΗ ΓΙΑ ΕΠΙΦΆΝΕΙΑ ΤΑΙΝΪΑΣ LED 2000X15.55X5.9MM ΑΣΗΜΪ
3371	VT-8118 ΚΙΤ ΤΟΠΟΘΈΤΗΣΗΣ ΜΕ ΔΙΑΧΥΤΗ ΓΙΑ ΕΠΙΦΆΝΕΙΑ ΤΑΙΝΪΑΣ LED 2000X30X20MM ΑΣΗΜΪ
3372	VT-8119 ΚΙΤ ΤΟΠΟΘΈΤΗΣΗΣ ΜΕ ΔΙΑΧΥΤΗ ΓΙΑ ΛΩΡΪΔΑ LED ΧΩΝΕΥΤΗ 2000X30X20MM ΑΣΗΜΪ

9956	VT-7104 ΚΙΤ ΤΟΠΟΘΕΤΗΣΗΣ ΜΕ ΔΙΑΧΥΤΗ ΓΙΑ ΓΩΝΙΑ ΤΑΙΝΙΑΣ LED 2000MM ΑΣΗΜΙ (ΠΑΚΕΤΟ 2 ΤΕΜΑΧΙΩΝ)
2610	VT-8117 ΚΙΤ ΤΟΠΟΘΕΤΗΣΗΣ ΜΕ ΔΙΑΧΥΤΗ ΓΙΑ ΕΠΙΦΑΝΕΙΑ ΤΑΙΝΙΑΣ LED 2000MM ΝΕΟΝ FLEX
2871	VT-8126 ΣΕΤ ΤΟΠΟΘΕΤΗΣΗΣ ΜΕ ΑΝΤΙΣΤΡΟΦΗ ΓΙΑ ΛΩΡΙΔΑ LED RECESSED 2000x50x35mm ΛΕΥΚΟ
2872	VT-8127 ΣΕΤ ΣΥΝΑΡΜΟΛΟΓΗΣΗΣ ΜΕ ΑΝΤΙΣΤΡΟΦΗ ΓΙΑ ΣΤΡΙΠ LED ΕΠΙΦΑΝΕΙΑ 2000x50x75mm ΛΕΥΚΟ
2873	VT-8113 ΣΕΤ ΣΥΝΑΡΜΟΛΟΓΗΣΗΣ ΜΕ DIFFUSER ΓΙΑ ΛΩΡΙΔΑ LED 2000x17.4x7mm ΜΑΥΡΟ
2874	VT-8109 ΣΕΤ ΣΥΝΑΡΜΟΛΟΓΗΣΗΣ ΜΕ ΑΝΤΙΣΤΡΟΦΗ ΓΙΑ ΣΤΡΑΙΓΜΑ LED 2000x15.8x15.8mm ΜΑΥΡΟ
2875	VT-8106 ΣΕΤ ΣΥΝΑΡΜΟΛΟΓΗΣΗΣ ΜΕ DIFFUSER ΓΙΑ ΛΩΡΙΔΑ LED 2000x24.7x7mm ΜΑΥΡΟ
2876	VT-8108 ΣΕΤ ΣΥΝΑΡΜΟΛΟΓΗΣΗΣ ΜΕ ΑΝΤΙΣΤΡΟΦΗ ΓΙΑ ΛΩΡΙΔΑ LED 2000x23.5x10mm ΜΑΥΡΟ
2877	VT-8114 ΣΕΤ ΣΥΝΑΡΜΟΛΟΓΗΣΗΣ ΜΕ ΑΝΤΙΣΤΡΟΦΗ ΓΙΑ ΛΩΡΙΔΑ LED 2000x19x19mm ΜΑΥΡΟ
2878	VT-8110 ΣΕΤ ΣΥΝΑΡΜΟΛΟΓΗΣΗΣ ΜΕ DIFFUSER ΓΙΑ ΛΩΡΙΔΑ LED 2000x17.2x14.4mm ΜΑΥΡΟ
2903	VT-8136 ΚΙΤ ΤΟΠΟΘΕΤΗΣΗΣ ΜΕ ΔΙΑΧΥΤΗ ΓΙΑ ΛΩΡΙΔΑ LED ΜΕ ΕΠΙΦΑΝΕΙΑ 2000MM
2904	VT-8137 ΚΙΤ ΤΟΠΟΘΕΤΗΣΗΣ ΜΕ ΔΙΑΧΥΤΗ ΓΙΑ ΛΩΡΙΔΑ LED ΧΩΝΕΥΤΗ 2000MM
2909	VT-8138 ΣΕΤ ΣΥΝΑΡΜΟΛΟΓΗΣΗΣ ΜΕ ΔΙΑΣΤΡΟΦΗ ΚΑΜΠΥΛΩΤΗ ΓΙΑ ΛΩΡΙΔΑ LED 2000x18x6MM ΑΣΗΜΕΡΙΝΟ ΚΟΥΣΤΙΧΙΟ
10320	VT-8156 ΣΕΤ ΣΥΝΑΡΜΟΛΟΓΗΣΗΣ ΜΕ ΑΝΤΙΣΤΡΟΦΗ ΓΙΑ ΛΩΡΙΔΑ LED 2000x24.7x7mm
10321	VT-8157 ΣΕΤ ΣΥΝΑΡΜΟΛΟΓΗΣΗΣ ΜΕ ΑΝΤΙΣΤΡΟΦΗ ΓΙΑ ΛΩΡΙΔΑ LED 2000x17.4x7mm
10322	VT-8158 ΣΕΤ ΣΥΝΑΡΜΟΛΟΓΗΣΗΣ ΜΕ ΑΝΤΙΔΡΑΣΤΗΡΑ ΓΙΑ ΣΤΡΙΠ LED 2000x15.8mmx15.8mm
23173	VT-8201 ΣΕΤ ΣΥΝΑΡΜΟΛΟΓΗΣΗΣ ΜΕ DIFFUSER ΓΙΑ LED STRIP 2000x55x15mm SILVER BODY
23174	VT-8202 ΣΕΤ ΣΥΝΑΡΜΟΛΟΓΗΣΗΣ ΜΕ DIFFUSER ΓΙΑ ΛΩΡΙΔΑ LED 2000x20x10mm SILVER BODY
23175	VT-8203 ΣΕΤ ΣΥΝΑΡΜΟΛΟΓΗΣΗΣ ΜΕ DIFFUSER ΓΙΑ LED STRIP 2000x20x10mm SILVER BODY
23176	VT-8204S ΣΕΤ ΣΥΝΑΡΜΟΛΟΓΗΣΗΣ ΜΕ ΑΝΤΙΣΤΡΟΦΗ ΓΙΑ ΛΩΡΙΔΑ LED 2000x30x10mm SILVER BODY
23177	VT-8204 ΣΕΤ ΣΥΝΑΡΜΟΛΟΓΗΣΗΣ ΜΕ DIFFUSER ΓΙΑ ΛΩΡΙΔΑ LED 2000x30x10mm SILVER BODY
23178	VT-8206S ΣΕΤ ΤΟΠΟΘΕΤΗΣΗΣ ΜΕ ΑΝΤΙΣΤΡΟΦΗ ΓΙΑ ΛΩΡΙΔΑ LED 2000x50x20mm SILVER BODY
23179	VT-8206 ΣΕΤ ΣΥΝΑΡΜΟΛΟΓΗΣΗΣ ΜΕ ΑΝΤΙΣΤΑΘΜΙΣΤΗ ΓΙΑ ΣΤΡΑΙΓΜΑ LED 2000x50x20mm ΑΣΗΜΕΝΙΟ ΣΩΜΑ
23180	VT-8208 ΣΕΤ ΣΥΝΑΡΜΟΛΟΓΗΣΗΣ ΜΕ DIFFUSER ΓΙΑ LED STRIP 2000x60x36mm SILVER BODY

HASZNÁLATI ÚTMUTATÓ ALUMÍNIUM PROFIL



02 METER
LENGTH

BEVEZETÉS

Köszönjük, hogy V-TAC terméket választott és vásárolt. A V-TAC a legjobbat fogja nyújtani Önnek. Kérjük, hogy a telepítés megkezdése előtt figyelmesen olvassa el ezeket az utasításokat, és a jövőbeni használatra tartsa kéznél ezt a kézikönyvet. Ha bármilyen más kérdése van, kérjük, forduljon a kereskedőnkhez vagy a helyi forgalmazóhoz, akitől a terméket vásárolta. Ők képzettek és készen állnak arra, hogy a lehető legjobban kiszolgálják Önt.

KARBANTARTÁS

- **Tisztítás előtti óvintézkedések:** A termék tisztítása előtt győződjön meg arról, hogy az le van választva a hálózati feszültségről. Ez alapvető biztonsági intézkedés az elektromos balesetek megelőzése érdekében.
- **Tisztítási eljárás:** A keret tisztításához használjon alkohollal enyhén megnedvesített pamutkendőt. Tartózkodjon a erős vegyi anyagokkal. Feltétlenül biztosítani kell, hogy a folyadék ne érintkezzen a termék elektromos alkatrészeivel.
- **Biztonsági intézkedések:** A tisztítást 8 év alatti gyermekek nem végezhetik, kivéve, ha a következőnél fiatalabbak felnőtt felügyelete. Ez a gyermek biztonságát és a termék megfelelő kezelését szolgálja.
- **A profil vágása:** Rögzítse az alumíniumprofil a helyére egy csavarhúzó vagy szorítók segítségével, hogy vágás közben ne mozduljon el. A legjobb illeszkedés érdekében ügyeljen arra, hogy a vágás a lehető legegyszerűbb legyen.
- **Simítsa ki a széleket:** A vágás után az alumíniumprofil élei élesek vagy egyenetlenek lehetnek. Használjon reszelőt a simítsa ki ezeket, ügyelve arra, hogy eltávolítsa az esetlegesen sérülést okozó fémmaradványokat.



Ez a jelölés azt jelzi, hogy ez a termék nem ártalmatlanítható más háztartási hulladékkal együtt.

BEÉPÍTÉSI ÚTMUTATÓ SÜLLYESZTETT BEÉPÍTÉS

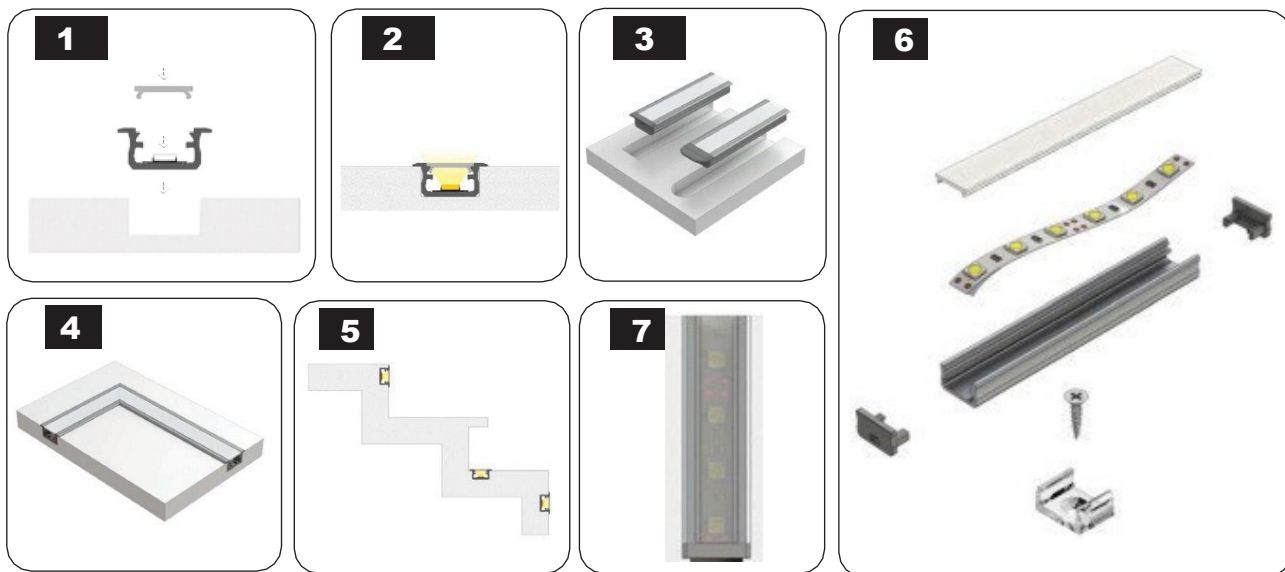

FELSZÍNI BEÉPÍTÉS



GIPSZ BEÉPÍTÉS

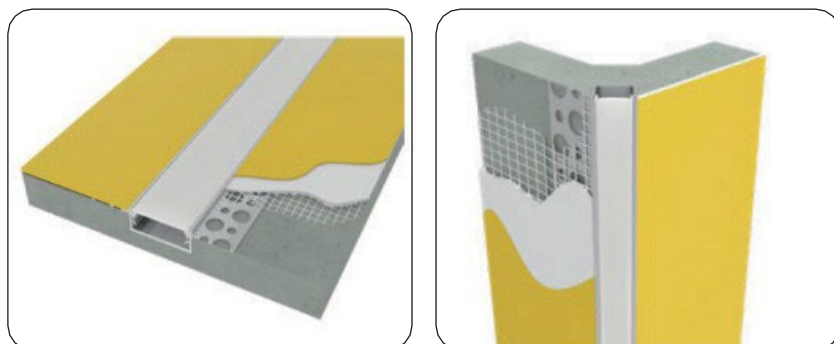

SAROKBEÉPÍTÉS

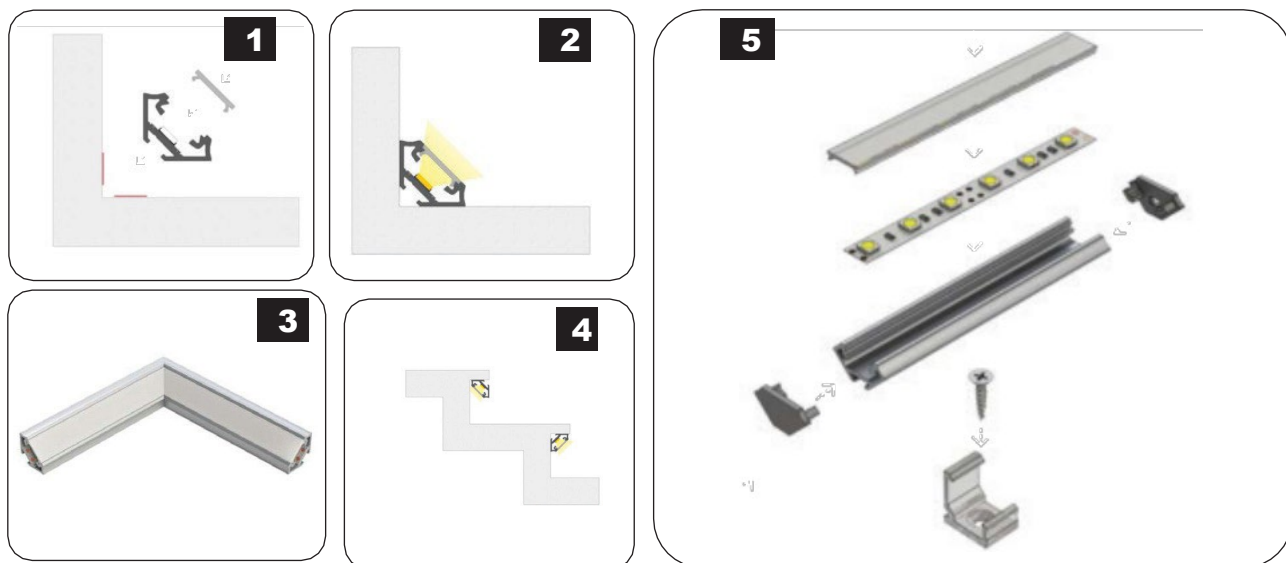

TERMÉKLEÍRÁSOK

SKU	LEÍRÁS
3350	VT-8106 SZERELŐKÉSZLET DIFFÚZORRAL LED SZALAGHOZ SÜLLYESZTETT 2000X24.7X7MM EZÜST SZÍNBEN
3351	VT-8107 SZERELŐKÉSZLET DIFFÚZORRAL LED SZALAGHOZ SÜLLYESZTETT 2000X24X14.2MM EZÜST SZÍNBEN
3352	VT-8108 SZERELŐKÉSZLET DIFFÚZORRAL LED SZALAGHOZ 2000X23.5X10MM FELÜLETRE EZÜST SZÍNBEN
3353	VT-8109 SZERELŐKÉSZLET DIFFÚZORRAL LED SZALAG SAROKHOZ 2000X15.8X15.8MM EZÜST
3354	VT-8110 SZERELŐKÉSZLET DIFFÚZORRAL LED SZALAGHOZ 2000X17.2X14.44MM FELÜLETRE EZÜST SZÍNBEN
3355	VT-8113 SZERELŐKÉSZLET DIFFÚZORRAL LED SZALAG FELÜLETRE 2000X17.4X7MM EZÜST
3356	VT-8114 SZERELŐKÉSZLET DIFFÚZORRAL LED SZALAG SAROKHOZ 2000X19X19MM EZÜST
3357	VT-8115 SZERELŐKÉSZLET DIFFÚZORRAL LED SZALAGHOZ SÜLLYESZTETT 2000X24.5X12.2MM EZÜST SZÍNBEN
3358	VT-8116 SZERELŐKÉSZLET DIFFÚZORRAL LED SZALAGHOZ 2000X17.4X12.1MM FELÜLETRE EZÜST SZÍNBEN
3359	VT-8101 SZERELŐSZERELÉK DIFFUSERrel LED STRIP RECESSED 2000x61.5x14MM SILVER LED STRIP-hez
3360	VT-8102 SZERELŐSZERELÉK DIFFUSERrel LED STRIP RECESSED 2000x52.1x13.3MM SILVER LED STRIP-hez
3361	VT-8103 SZERELŐSZERELÉK DIFFUSERrel LED STRIP 2000x50.12x22.34MM SILVER
3362	VT-8104 SZERELŐSZERELÉK DIFFUSERrel LED STRIP RECESSED 2000x45.4x25.14MM SILVER LED STRIP-hez
3363	VT-8105 SZERELŐSZERELÉK DIFFUSERrel LED STRIP SARKOS 2000x20.3x30MM SILVER LED-hez
3364	VT-8114-W SZERELŐKÉSZLET DIFFÚZORRAL LED SZALAG PCB 12MM SAROKHOZ 2000X19X19MM FEHÉR
3365	VT-8113-W SZERELŐKÉSZLET DIFFÚZORRAL LED SZALAG PCB 12MM FELÜLETRE 2000X17.4X7MM FEHÉR
3366	VT-8110-W SZERELŐKÉSZLET DIFFÚZORRAL LED SZALAGHOZ 20MM FELÜLETRE 2000X17.2X14.44MM FEHÉR
3367	VT-8108-W SZERELŐKÉSZLET DIFFÚZORRAL LED SZALAGHOZ 20MM FELÜLETRE 2000X23.5X10.4MM FEHÉR
3368	VT-8122 SZERELŐKÉSZLET DIFFÚZORRAL LED SZALAG PCB 12MM SÜLLYESZTETT 2000X24.7X7MM FEHÉR
3369	VT-8123 SZERELŐKÉSZLET DIFFÚZORRAL LED SZALAG PCB 12MM SAROK 2000X15.8X15.8MM FEHÉR
3370	VT-9327 SZERELŐKÉSZLET DIFFÚZORRAL LED SZALAG FELÜLETRE 2000X15.55X5.9MM EZÜST
3371	VT-8118 SZERELŐKÉSZLET DIFFÚZORRAL LED SZALAGHOZ 2000X30X20MM FELÜLETRE EZÜST
3372	VT-8119 SZERELŐKÉSZLET DIFFÚZORRAL LED SZALAGHOZ SÜLLYESZTETT 2000X30X20MM EZÜST SZÍNBEN

9956	VT-7104 SZERELŐKÉSZLET DIFFÚZORRAL LED SZALAG SAROK 2000MM EZÜST (2DB CSOMAG)
2610	VT-8117 SZERELŐKÉSZLET DIFFÚZORRAL LED SZALAGHOZ 2000MM NEON FLEX FELÜLETRE
2871	VT-8126 SZERELŐSZERELÉK DIFFUSERrel LED STRIP RECESSED 2000x50x35mm FEHÉR
2872	VT-8127 SZERELŐSZERELET DIFFUSERrel LED STRIP FELÜLETES 2000x50x75mm FEHÉR
2873	VT-8113 SZERELŐSZERELET DIFFUSERrel LED STRIP 2000x17.4x7mm FEKETE LED STRIP-hez
2874	VT-8109 SZERELŐKÉSZLET DIFFUSERrel LED STRIP 2000x15.8x15.8mm FEKETE LED STRIP-hez
2875	VT-8106 SZERELŐSZERELET DIFFUSERrel LED STRIP 2000x24.7x7mm FEKETE LED STRIP-hez
2876	VT-8108 SZERELŐSZERELÉK DIFFUSERrel LED STRIP 2000x23.5x10mm FEKETE LED STRIP-hez
2877	VT-8114 SZERELŐSZERELET DIFFUSERrel LED STRIP 2000x19x19mm FEKETE LED STRIP 2000x19x19mm FEKETE
2878	VT-8110 SZERELŐKÉSZLET DIFFUSERrel LED STRIP 2000x17.2x14.4mm FEKETE LED STRIP-hez
2903	VT-8136 SZERELŐKÉSZLET DIFFÚZORRAL LED SZALAGHOZ 2000MM-ES FELÜLETŰ LED SZALAGHOZ
2904	VT-8137 SZERELŐKÉSZLET DIFFÚZORRAL LED SZALAGHOZ SÜLLYESZTETT 2000MM-ES LED SZALAGHOZ
2909	VT-8138 SZERELŐSZERELÉK DIFFUSERrel hajlítható LED STRIP 2000x18x6MM ezüst házhoz
10320	VT-8156 SZERELŐSZERELET DIFFUSERrel LED STRIP 2000x24.7x7mm LED STRIP 2000x24.7x7mm-hez
10321	VT-8157 SZERELŐSZERELET DIFFUSERrel LED STRIP 2000x17.4x7mm-es LED STRIP-hez
10322	VT-8158 SZERELŐSZERELET DIFFUSERrel LED STRIP 2000x15.8mmx15.8mm LED STRIP 2000x15.8mmhez
23173	VT-8201 SZERELŐSZERELÉK DIFFUSERrel LED STRIP 2000x55x15mm SILVER BODY-hoz
23174	VT-8202 SZERELŐSZERELÉK DIFFUSERrel LED STRIP 2000x20x10mm SILVER BODY LED-hez
23175	VT-8203 SZERELŐSZERELÉK DIFFUSERrel LED STRIP 2000x20x10mm SILVER BODY LED-hez
23176	VT-8204S SZERELŐSZERELÉK DIFFUSERrel LED STRIP 2000x30x10mm SILVER BODY LED-hez
23177	VT-8204 SZERELŐSZERELÉK DIFFUSERrel LED STRIP 2000x30x10mm SILVER BODY LED-hez
23178	VT-8206S SZERELŐSZERELÉK DIFFUSERrel LED STRIP 2000x50x20mm SILVER BODY-hoz
23179	VT-8206 SZERELŐSZERELÉK DIFFUSERrel LED STRIP 2000x50x20mm SILVER BODY-hoz
23180	VT-8208 SZERELŐSZERELET DIFFUSERrel LED STRIP 2000x60x36mm SILVER BODY-hoz



Meaningful Innovation.

WEEE Number: 80133970

MANUALE DI ISTRUZIONI

PROFILO IN ALLUMINIO

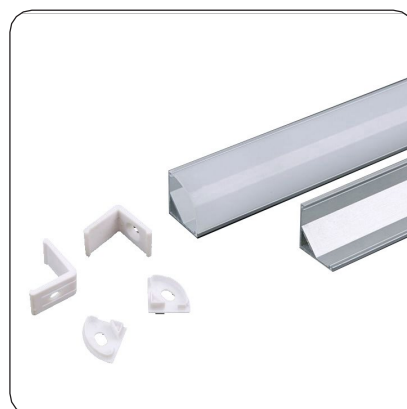

02 METER
LENGTH

INTRODUZIONE

Grazie per aver scelto e acquistato un prodotto V-TAC. V-TAC vi servirà al meglio. Leggere attentamente le presenti istruzioni prima di iniziare l'installazione e conservare il manuale per future consultazioni. Per qualsiasi altra domanda, si prega di contattare il nostro rivenditore o il venditore locale presso il quale è stato acquistato il prodotto. Sono addestrati e pronti a servirvi al meglio.

MANUTENZIONE

- **Precauzioni per la pulizia:** Prima di pulire il prodotto, assicurarsi che sia scollegato dalla rete elettrica. Si tratta di una misura di sicurezza fondamentale per evitare qualsiasi incidente elettrico.
- **Procedura di pulizia:** Per pulire il telaio, utilizzare un panno di cotone leggermente inumidito con alcol. Astenersi dal utilizzare potenti agenti chimici. È indispensabile assicurarsi che il liquido non entri in contatto con i componenti elettrici del prodotto.
- **Misure di sicurezza:** La pulizia non deve essere effettuata da bambini di età inferiore a 8 anni, a meno che non siano sotto supervisione di un adulto. Questo per garantire la sicurezza del bambino e il corretto utilizzo del prodotto.
- **Taglio del profilo:** Fissare il profilo di alluminio in posizione utilizzando una morsa o dei morsetti per garantire che non si muova durante il taglio. Assicurarsi che il taglio sia il più rettilineo possibile per ottenere il migliore adattamento.
- **Levigare i bordi:** Dopo il taglio, i bordi del profilo di alluminio potrebbero essere taglienti o irregolari. Utilizzare una lima per lisciarli, facendo attenzione a rimuovere eventuali bave metalliche che potrebbero causare danni.



Questo marchio indica che questo prodotto non deve essere smaltito con altri rifiuti domestici.

IN CASO DI DOMANDE/PROBLEMI CON IL PRODOTTO, CONTATTATECI ALL'INDIRIZZO: SUPPORT@V-TAC.EU PER ULTERIORI INFORMAZIONI SULLA GAMMA DI PRODOTTI, SI PREGA DI CONTATTARE IL NOSTRO DISTRIBUTORE O I RIVENDITORI PIÙ VICINI.

V-TAC EUROPE LTD. BULGARIA, PLOVDIV 4000, BUL.L.KARAVELOW 9B

ISTRUZIONI PER L'INSTALLAZIONE

INSTALLAZIONE AD INCASSO

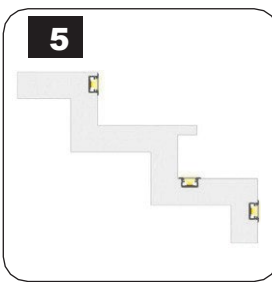
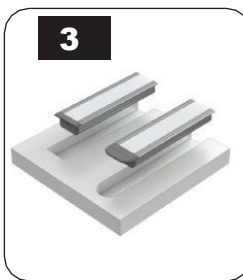
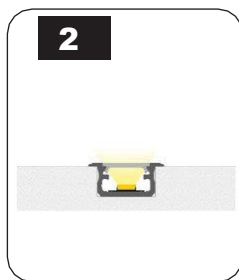
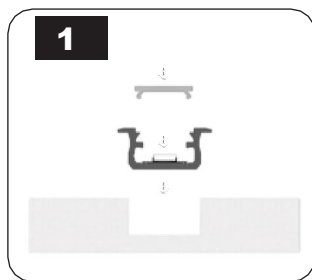

INSTALLAZIONE IN SUPERFICIE

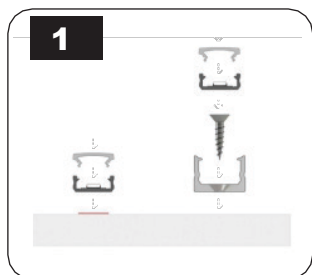

INSTALLAZIONE DEL GESSO

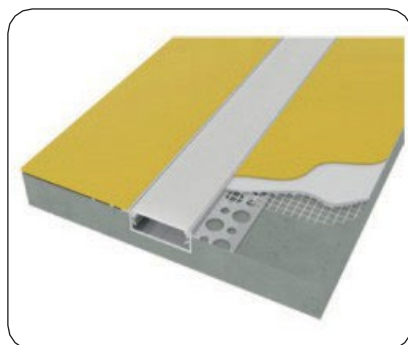

INSTALLAZIONE AD ANGOLO

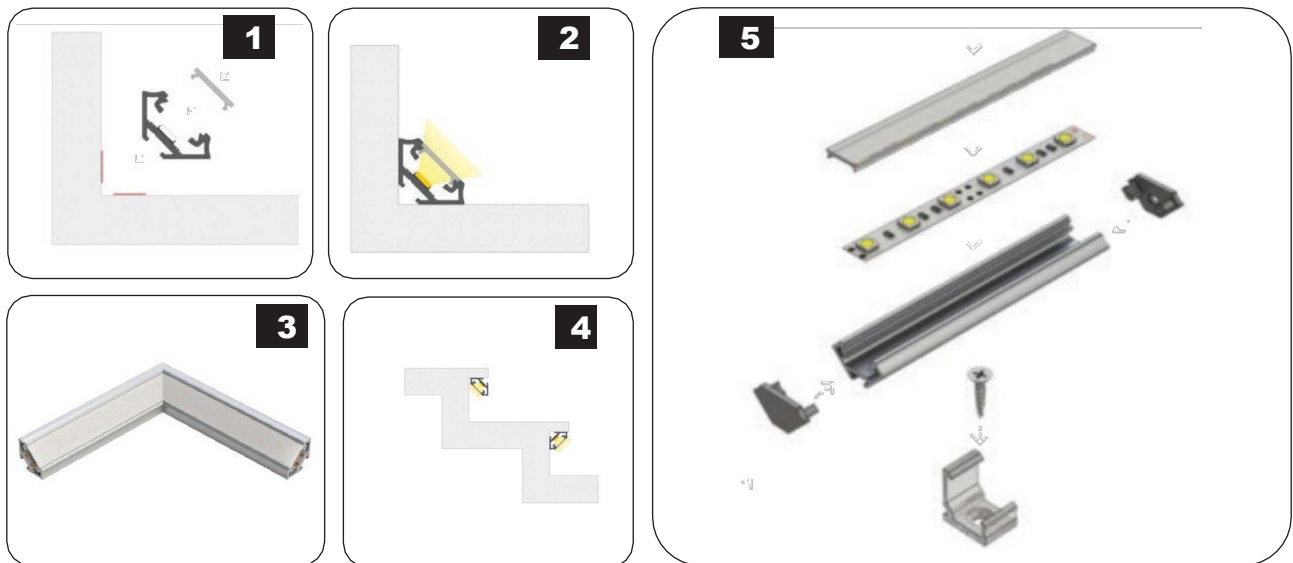

DESCRIZIONI DEI PRODOTTI

SKU	DESCRIZIONE
3350	VT-8106 KIT DI MONTAGGIO CON DIFFUSORE PER STRISCIA LED DA INCASSO 2000X24,7X7MM ARGENTO
3351	VT-8107 KIT DI MONTAGGIO CON DIFFUSORE PER STRISCE LED DA INCASSO 2000X24X14,2MM ARGENTO
3352	VT-8108 KIT DI MONTAGGIO CON DIFFUSORE PER STRISCE LED DI SUPERFICIE 2000X23,5X10MM ARGENTO
3353	VT-8109 KIT DI MONTAGGIO CON DIFFUSORE PER STRISCE LED ANGOLARI 2000X15,8X15,8MM ARGENTO
3354	VT-8110 KIT DI MONTAGGIO CON DIFFUSORE PER STRISCE LED DI SUPERFICIE 2000X17,2X14,44 MM ARGENTO
3355	VT-8113 KIT DI MONTAGGIO CON DIFFUSORE PER STRISCIA LED DI SUPERFICIE 2000X17,4X7MM ARGENTO
3356	VT-8114 KIT DI MONTAGGIO CON DIFFUSORE PER STRISCIA LED ANGOLARE 2000X19X19MM ARGENTO
3357	VT-8115 KIT DI MONTAGGIO CON DIFFUSORE PER STRISCE LED DA INCASSO 2000X24,5X12,2MM ARGENTO
3358	VT-8116 KIT DI MONTAGGIO CON DIFFUSORE PER STRISCE LED DI SUPERFICIE 2000X17,4X12,1MM ARGENTO
3359	VT-8101 KIT DI MONTAGGIO CON DIFFUSORE PER STRISCIA LED INCASSATA 2000x61,5x14MM ARGENTO
3360	VT-8102 KIT DI MONTAGGIO CON DIFFUSORE PER STRISCIA LED INCASSATA 2000x52,1x13,3MM ARGENTO
3361	VT-8103 KIT DI MONTAGGIO CON DIFFUSORE PER STRISCIA LED 2000x50,12x22,34MM ARGENTO
3362	VT-8104 KIT DI MONTAGGIO CON DIFFUSORE PER STRISCIA LED INCASSATA 2000x45,4x25,14MM ARGENTO
3363	VT-8105 KIT DI MONTAGGIO CON DIFFUSORE PER STRISCIA LED CORNER 2000x20,3x30MM ARGENTO
3364	VT-8114-W KIT DI MONTAGGIO CON DIFFUSORE PER STRISCIA LED PCB 12MM ANGOLARE 2000X19X19MM BIANCO
3365	VT-8113-W KIT DI MONTAGGIO CON DIFFUSORE PER STRISCIA LED PCB 12MM SUPERFICIE 2000X17,4X7MM BIANCO
3366	VT-8110-W KIT DI MONTAGGIO CON DIFFUSORE PER STRISCIA LED PCB 20MM SUPERFICIE 2000X17,2X14,44MM BIANCO
3367	VT-8108-W KIT DI MONTAGGIO CON DIFFUSORE PER STRISCIA LED PCB 20MM SUPERFICIE 2000X23,5X10,4MM BIANCO
3368	VT-8122 KIT DI MONTAGGIO CON DIFFUSORE PER STRISCE LED PCB 12MM DA INCASSO 2000X24,7X7MM BIANCO
3369	VT-8123 KIT DI MONTAGGIO CON DIFFUSORE PER STRISCIA LED PCB 12MM ANGOLO 2000X15,8X15,8MM BIANCO
3370	VT-9327 KIT DI MONTAGGIO CON DIFFUSORE PER STRISCE LED DI SUPERFICIE 2000X15,55X5,9MM ARGENTO
3371	VT-8118 KIT DI MONTAGGIO CON DIFFUSORE PER STRISCE LED DI SUPERFICIE 2000X30X20MM ARGENTO
3372	VT-8119 KIT DI MONTAGGIO CON DIFFUSORE PER STRISCE LED DA INCASSO 2000X30X20MM ARGENTO

9956	VT-7104 KIT DI MONTAGGIO CON DIFFUSORE PER STRISCIA LED ANGOLARE 2000MM ARGENTO (CONFEZIONE DA 2 PEZZI)
2610	VT-8117 KIT DI MONTAGGIO CON DIFFUSORE PER STRISCIA LED DI SUPERFICIE 2000MM NEON FLEX
2871	VT-8126 KIT DI MONTAGGIO CON DIFFUSORE PER STRISCIA LED INCASSATA 2000x50x35mm BIANCO
2872	VT-8127 KIT DI MONTAGGIO CON DIFFUSORE PER STRISCIA LED SUPERIORE 2000x50x75mm BIANCO
2873	VT-8113 KIT DI MONTAGGIO CON DIFFUSORE PER STRISCE LED 2000x17,4x7mm NERO
2874	VT-8109 KIT DI MONTAGGIO CON DIFFUSORE PER STRISCE LED 2000x15,8x15,8mm NERO
2875	VT-8106 KIT DI MONTAGGIO CON DIFFUSORE PER STRISCE LED 2000x24,7x7mm NERO
2876	VT-8108 KIT DI MONTAGGIO CON DIFFUSORE PER STRISCE LED 2000x23,5x10 mm NERO
2877	VT-8114 KIT DI MONTAGGIO CON DIFFUSORE PER STRISCE LED 2000x19x19mm NERO
2878	VT-8110 KIT DI MONTAGGIO CON DIFFUSORE PER STRISCE LED 2000x17,2x14,4 mm NERO
2903	VT-8136 KIT DI MONTAGGIO CON DIFFUSORE PER STRISCE LED A SUPERFICIE 2000MM
2904	VT-8137 KIT DI MONTAGGIO CON DIFFUSORE PER STRISCE LED DA INCASSO 2000MM
2909	VT-8138 KIT DI MONTAGGIO CON DIFFUSORE PIEGHEVOLE PER STRISCE LED 2000x18x6MM IN ARGENTO
10320	VT-8156 KIT DI MONTAGGIO CON DIFFUSORE PER STRISCIA LED 2000x24,7x7mm
10321	VT-8157 KIT DI MONTAGGIO CON DIFFUSORE PER STRISCIA LED 2000x17,4x7 mm
10322	VT-8158 KIT DI MONTAGGIO CON DIFFUSORE PER STRISCIA LED 2000x15,8mmx15,8mm
23173	VT-8201 KIT DI MONTAGGIO CON DIFFUSORE PER STRISCE LED 2000x55x15mm CORPO ARGENTO
23174	VT-8202 KIT DI MONTAGGIO CON DIFFUSORE PER STRISCE LED 2000x20x10mm CORPO ARGENTO
23175	VT-8203 KIT DI MONTAGGIO CON DIFFUSORE PER STRISCE LED 2000x20x10mm CORPO ARGENTO
23176	VT-8204S KIT DI MONTAGGIO CON DIFFUSORE PER STRISCE LED 2000x30x10mm CORPO ARGENTO
23177	VT-8204 KIT DI MONTAGGIO CON DIFFUSORE PER STRISCE LED 2000x30x10mm CORPO ARGENTO
23178	VT-8206S KIT DI MONTAGGIO CON DIFFUSORE PER STRISCIA LED 2000x50x20mm CORPO ARGENTO
23179	VT-8206 KIT DI MONTAGGIO CON DIFFUSORE PER STRISCIA LED 2000x50x20mm CORPO ARGENTO
23180	VT-8208 KIT DI MONTAGGIO CON DIFFUSORE PER STRISCE LED 2000x60x36 mm CORPO ARGENTO



Meaningful Innovation.

WEEE Number: 80133970

INSTRUKCJA OBSŁUGI

PROFIL ALUMINIOWY



02 METER
LENGTH

WPROWADZENIE

Dziękujemy za wybranie i zakup produktu V-TAC. Firma V-TAC będzie służyć jak najlepiej. Przed rozpoczęciem instalacji należy dokładnie zapoznać się z niniejszą instrukcją i zachować ją do wykorzystania w przyszłości. W razie jakichkolwiek pytań prosimy o kontakt z naszym dealerem lub lokalnym sprzedawcą, od którego zakupiono produkt. Są oni przeszkoleni i gotowi do świadczenia usług na najwyższym poziomie.

KONSERWACJA

- **Środki ostrożności przed czyszczeniem:** Przed przystąpieniem do czyszczenia produktu należy upewnić się, że jest on odłączony od zasilania. Jest to kluczowy środek bezpieczeństwa zapobiegający wszelkim awariom elektrycznym.
- **Procedura czyszczenia:** Do czyszczenia ramy należy używać bawełnianej szmatki lekko zwilżonej alkoholem. Powstrzymać się od przy użyciu silnych środków chemicznych. Konieczne jest upewnienie się, że płyn nie wejdzie w kontakt z elementami elektrycznymi produktu.
- **Środki bezpieczeństwa:** Czyszczenie nie powinno być wykonywane przez dzieci w wieku poniżej 8 lat, chyba że są one poniżej nadzór osoby dorosłej. Ma to na celu zapewnienie bezpieczeństwa dziecka i właściwego obchodzenia się z produktem.
- **Cięcie profilu:** Zabezpiecz profil aluminiowy na miejscu za pomocą imadła lub zacisków, aby nie poruszał się podczas cięcia. Upewnij się, że cięcie jest tak proste, jak to możliwe, aby zapewnić najlepsze dopasowanie.
- **Wyglądanie krawędzi:** Po cięciu krawędzie profilu aluminiowego mogą być ostre lub nierówne. Użyj pilnika, aby wygładzić je, uważając, aby usunąć wszelkie metalowe zadziory, które mogą potencjalnie spowodować uszkodzenie.



To oznaczenie wskazuje, że tego produktu nie należy wyrzucać razem z innymi odpadami domowymi.

W PRZYPADKU JAKICHKOLWIEK PYTAŃ/PROBLEMÓW Z PRODUKTEM, PROSIMY O KONTAKT POD ADRESEM: SUPPORT@V-TAC.EU. ABY UZYSKAĆ WIĘCEJ INFORMACJI, PROSIMY O KONTAKT Z NASZYM DYSTRYBUTOREM LUB NAJBLIŻSZYMI DEALERAMI.

V-TAC EUROPE LTD. BUŁGARIA, PLOVDIV 4000, BUL.L.KARAVELOW 9B

INSTRUKCJE MONTAŻU WPUSZCZANEGO

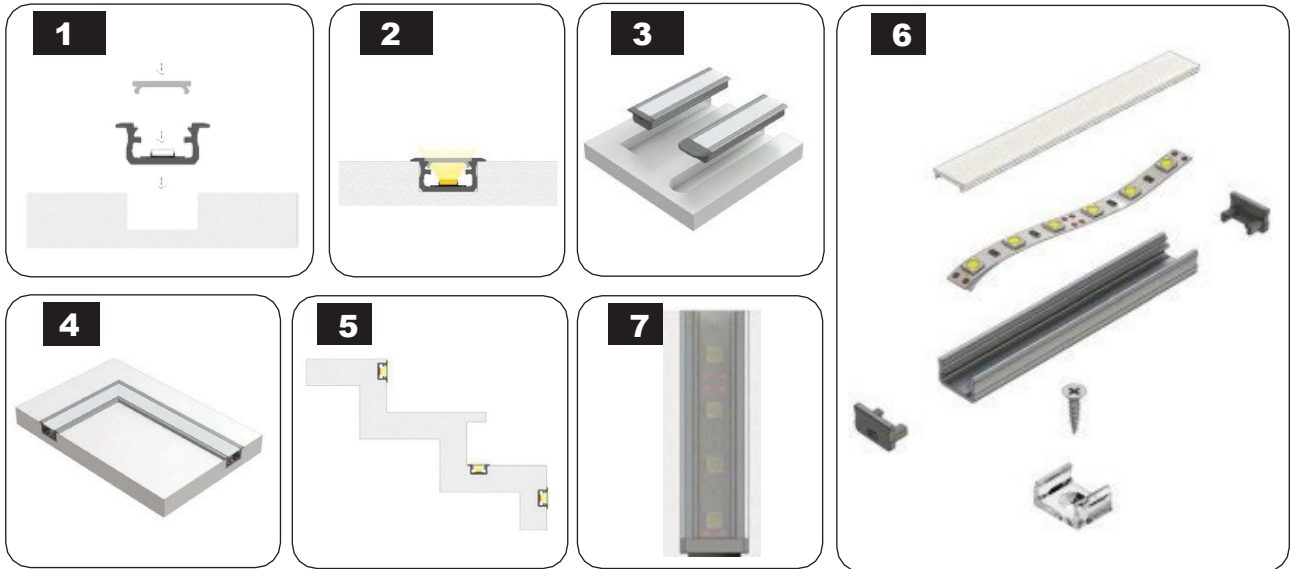

MONTAŻ POWIERZCHNIOWY



INSTALACJA GIPSOWA

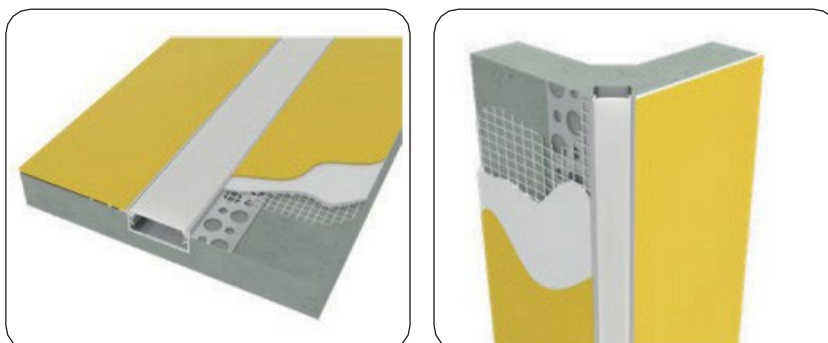

INSTALACJA NAROŻNA

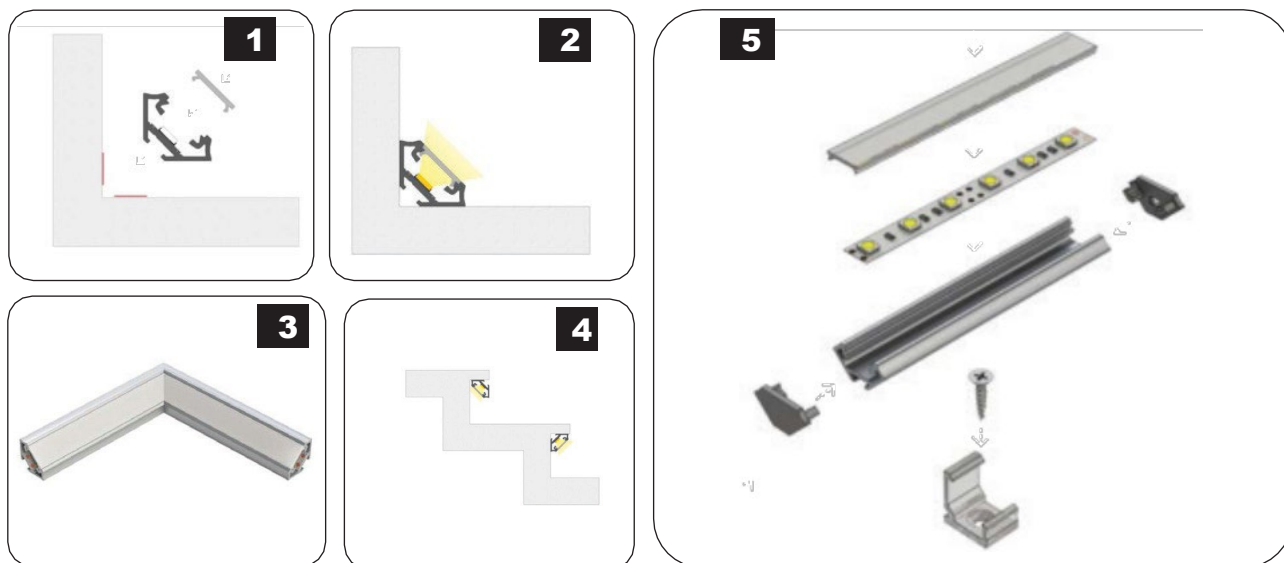

OPISY PRODUKTÓW

SKU	OPIS
3350	VT-8106 ZESTAW MONTAŻOWY Z DYFUZOREM DO TAŚMY LED WPUSZCZANEJ 2000X24.7X7MM SREBRNY
3351	VT-8107 ZESTAW MONTAŻOWY Z DYFUZOREM DO TAŚMY LED WPUSZCZANEJ 2000X24X14.2MM SREBRNY
3352	VT-8108 ZESTAW MONTAŻOWY Z DYFUZOREM DO TAŚMY LED SURFACE 2000X23.5X10MM SREBRNY
3353	VT-8109 ZESTAW MONTAŻOWY Z DYFUZOREM DO TAŚMY LED NAROŻNEJ 2000X15.8X15.8MM SREBRNY
3354	VT-8110 ZESTAW MONTAŻOWY Z DYFUZOREM DO TAŚMY LED SURFACE 2000X17.2X14.44MM SREBRNY
3355	VT-8113 ZESTAW MONTAŻOWY Z DYFUZOREM DO TAŚMY LED SURFACE 2000X17.4X7MM SREBRNY
3356	VT-8114 ZESTAW MONTAŻOWY Z DYFUZOREM DO TAŚMY LED NAROŻNEJ 2000X19X19MM SREBRNY
3357	VT-8115 ZESTAW MONTAŻOWY Z DYFUZOREM DO TAŚM LED WPUSZCZANYCH 2000X24.5X12.2MM SREBRNY
3358	VT-8116 ZESTAW MONTAŻOWY Z DYFUZOREM DO TAŚMY LED SURFACE 2000X17.4X12.1MM SREBRNY
3359	VT-8101 ZESTAW MONTAŻOWY Z DYFUZOREM DO ŚWIATŁA LED WPROWADZONEGO 2000x61.5x14MM SREBRNY
3360	VT-8102 ZESTAW MONTAŻOWY Z DYFUZOREM DO ŚWIATŁA LED 2000x52.1x13.3MM SREBRNY
3361	VT-8103 ZESTAW MONTAŻOWY Z DYFUZOREM DO ŚWIATŁA LED 2000x50.12x22.34MM SREBRNY
3362	VT-8104 ZESTAW MONTAŻOWY Z DYFUZOREM DO ŚWIATŁA LED WCIĘTEGO 2000x45.4x25.14MM SREBRNY
3363	VT-8105 ZESTAW MONTAŻOWY Z DYFUZOREM DO LISTWY LED 2000x20.3x30MM SREBRNY
3364	VT-8114-W ZESTAW MONTAŻOWY Z DYFUZOREM DO TAŚMY LED PCB 12MM NAROŻNIK 2000X19X19MM BIAŁY
3365	VT-8113-W ZESTAW MONTAŻOWY Z DYFUZOREM DO TAŚMY LED PCB 12MM POWIERZCHNIA 2000X17.4X7MM BIAŁY
3366	VT-8110-W ZESTAW MONTAŻOWY Z DYFUZOREM DO TAŚMY LED PCB 20MM POWIERZCHNIA 2000X17.2X14.44MM BIAŁY
3367	VT-8108-W ZESTAW MONTAŻOWY Z DYFUZOREM DO TAŚMY LED PCB 20MM POWIERZCHNIA 2000X23.5X10.4MM BIAŁY
3368	VT-8122 ZESTAW MONTAŻOWY Z DYFUZOREM DO TAŚMY LED PCB 12MM WPUSZCZANEJ 2000X24.7X7MM BIAŁY
3369	VT-8123 ZESTAW MONTAŻOWY Z DYFUZOREM DO TAŚMY LED PCB 12MM NAROŻNIK 2000X15.8X15.8MM BIAŁY
3370	VT-9327 ZESTAW MONTAŻOWY Z DYFUZOREM DO TAŚMY LED SURFACE 2000X15.55X5.9MM SREBRNY
3371	VT-8118 ZESTAW MONTAŻOWY Z DYFUZOREM DO TAŚMY LED SURFACE 2000X30X20MM SREBRNY
3372	VT-8119 ZESTAW MONTAŻOWY Z DYFUZOREM DO TAŚMY LED WPUSZCZANEJ 2000X30X20MM SREBRNY

9956	VT-7104 ZESTAW MONTAŻOWY Z DYFUZOREM DO TAŚMY LED NAROŻNIK 2000MM SREBRNY (OPAKOWANIE 2SZT)
2610	VT-8117 ZESTAW MONTAŻOWY Z DYFUZOREM DO TAŚMY LED SURFACE 2000MM NEON FLEX
2871	VT-8126 ZESTAW MONTAŻOWY Z DYFUZOREM DO TAŚMY LED WPROWADZONEJ 2000x50x35mm BIAŁY
2872	VT-8127 ZESTAW MONTAŻOWY Z DYFUZOREM DO TAŚM LED 2000x50x75mm BIAŁY
2873	VT-8113 ZESTAW MONTAŻOWY Z DYFUZOREM DO TAŚMY LED 2000x17.4x7mm CZARNY
2874	VT-8109 ZESTAW MONTAŻOWY Z DYFUZOREM DO TAŚMY LED 2000x15.8x15.8mm CZARNY
2875	VT-8106 ZESTAW MONTAŻOWY Z DYFUZOREM DO LISTWY LED 2000x24.7x7mm CZARNY
2876	VT-8108 ZESTAW MONTAŻOWY Z DYFUZOREM DO LISTWY LED 2000x23.5x10mm CZARNY
2877	VT-8114 ZESTAW MONTAŻOWY Z DYFUZOREM DO TAŚMY LED 2000x19x19mm CZARNY
2878	VT-8110 ZESTAW MONTAŻOWY Z DYFUZOREM DO TAŚMY LED 2000x17.2x14.4mm CZARNY
2903	VT-8136 ZESTAW MONTAŻOWY Z DYFUZOREM DO TAŚMY LED O POWIERZCHNI 2000MM
2904	VT-8137 ZESTAW MONTAŻOWY Z DYFUZOREM DO TAŚMY LED WPUSZCZANEJ 2000MM
2909	VT-8138 ZESTAW MONTAŻOWY Z DYFUZOREM ZGINANYM DO TAŚMY LED 2000x18x6MM W SREBRNEJ OPRAWIE
10320	VT-8156 ZESTAW MONTAŻOWY Z DYFUZOREM DO ŚWIATŁA LED 2000x24.7x7mm
10321	VT-8157 ZESTAW MONTAŻOWY Z DYFUZOREM DO TAŚMY LED 2000x17.4x7mm
10322	VT-8158 ZESTAW MONTAŻOWY Z DYFUZOREM DO LISTWY LED 2000x15.8mmx15.8mm
23173	VT-8201 ZESTAW MONTAŻOWY Z DYFUZOREM DO ŚWIATŁA LED 2000x55x15mm SREBRNA KAROSERIA
23174	VT-8202 ZESTAW MONTAŻOWY Z DYFUZOREM DO ŚWIATŁA LED 2000x20x10mm SREBRNA KAROSERIA
23175	VT-8203 ZESTAW MONTAŻOWY Z DYFUZOREM DO ŚWIATŁA LED 2000x20x10mm SREBRNA KAROSERIA
23176	VT-8204S ZESTAW MONTAŻOWY Z DYFUZOREM DO ŚWIATŁA LED 2000x30x10mm SREBRNA KAROSERIA
23177	VT-8204 ZESTAW MONTAŻOWY Z DYFUZOREM DO ŚWIATŁA LED 2000x30x10mm SREBRNA KAROSERIA
23178	VT-8206S ZESTAW MONTAŻOWY Z DYFUZOREM DO ŚWIATŁA LED 2000x50x20mm SREBRNA KAROSERIA
23179	VT-8206 ZESTAW MONTAŻOWY Z DYFUZOREM DO ŚWIATŁA LED 2000x50x20mm SREBRNY KORPUS
23180	VT-8208 ZESTAW MONTAŻOWY Z DYFUZOREM DO ŚWIATŁA LED 2000x60x36mm SREBRNA KAROSERIA



Meaningful Innovation.

WEEE Number: 80133970

MANUAL DE INSTRUÇÕES

PERFIL DE ALUMÍNIO



02 METER
LENGTH

INTRODUÇÃO

Obrigado por selecionar e comprar o produto V-TAC. A V-TAC irá servi-lo da melhor forma. Por favor, leia atentamente estas instruções antes de iniciar a instalação e mantenha este manual à mão para referência futura. Se tiver qualquer outra dúvida, contacte o nosso revendedor ou o vendedor local a quem adquiriu o produto. Eles têm formação e estão prontos para o servir da melhor forma.

MANUTENÇÃO

- **Precauções de pré-limpeza:** Antes de limpar o produto, certifique-se de que este está desligado da corrente eléctrica. Esta é uma medida de segurança crucial para evitar qualquer acidente elétrico.
- **Procedimento de limpeza:** Utilizar um pano de algodão ligeiramente humedecido com álcool para limpar a moldura. Evite utilizando agentes químicos potentes. É imperativo garantir que o líquido não entra em contacto com os componentes eléctricos do produto.
- **Medidas de segurança:** A limpeza não deve ser efectuada por crianças com menos de 8 anos de idade, a não ser que tenham menos de supervisão de um adulto. O objetivo é garantir a segurança da criança e o manuseamento correto do produto.
- **Cortar o perfil:** Fixe o perfil de alumínio no lugar usando um torno ou grampos para garantir que ele não se mova durante o corte. Certifique-se de que o corte é o mais reto possível para o melhor ajuste.
- **Alisar as arestas:** Após o corte, as arestas do perfil de alumínio podem estar afiadas ou desiguais. Utilize uma lima para Alise-os, tendo o cuidado de remover quaisquer rebarbas metálicas que possam causar danos.



Esta marcação indica que este produto não deve ser eliminado juntamente com outros resíduos domésticos.

EM CASO DE QUALQUER DÚVIDA/PROBLEMA COM O PRODUTO, CONTACTE-NOS ATRAVÉS DE: SUPPORT@V-TAC.EU PARA MAIS PRODUTOS, CONTACTE O NOSSO DISTRIBUIDOR OU OS REVENDEDORES MAIS PRÓXIMOS.

V-TAC EUROPE LTD. BULGÁRIA, PLOVDIV 4000, BUL.L.KARAVELOW 9B

INSTRUÇÕES DE INSTALAÇÃO

INSTALAÇÃO ENCASTRADA

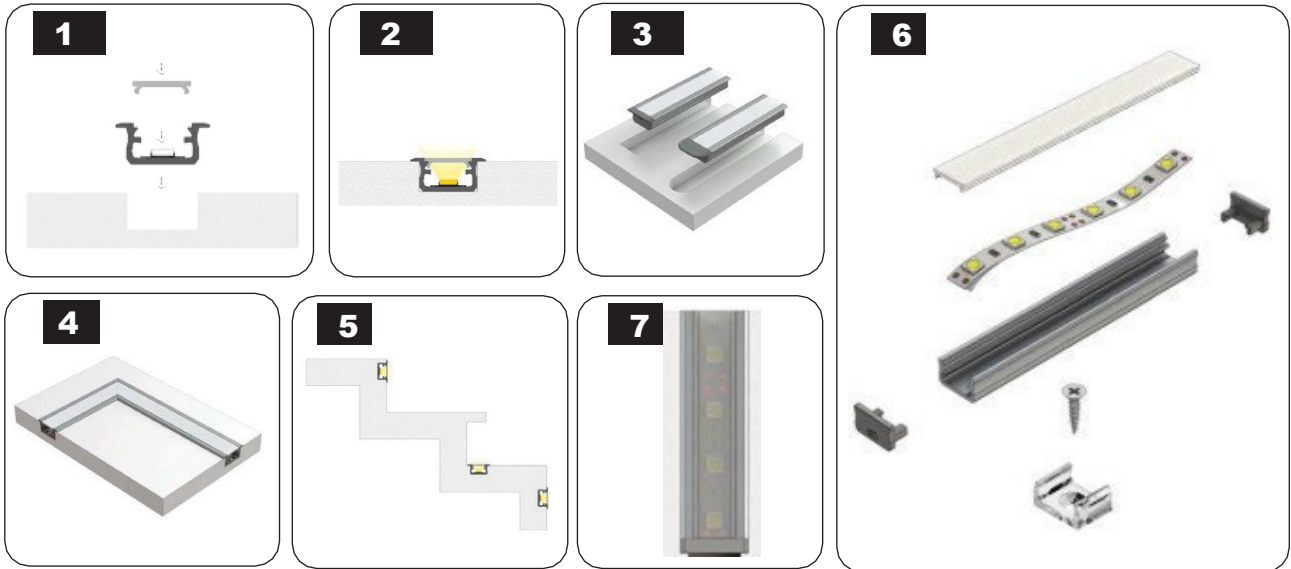

INSTALAÇÃO DE SUPERFÍCIE



INSTALAÇÃO DE GESSO

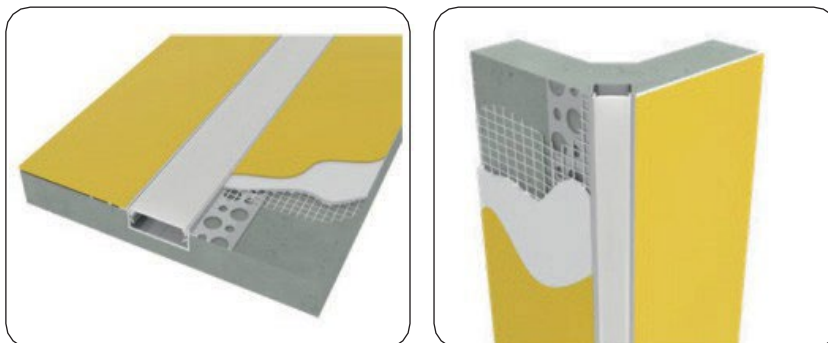

INSTALAÇÃO DE CANTO

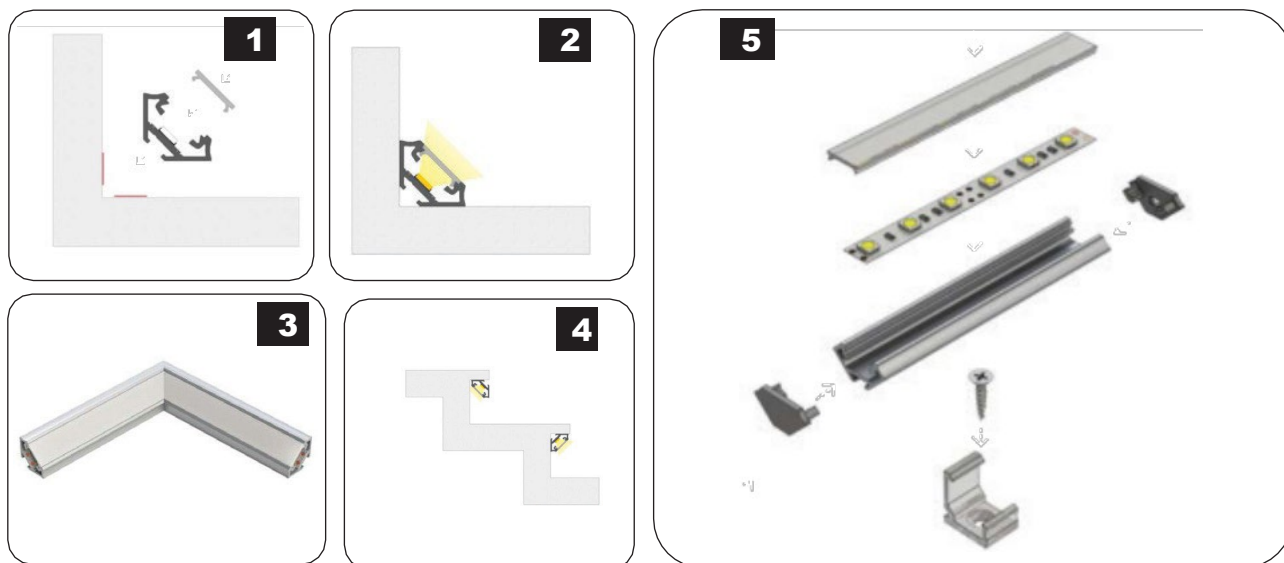

DESCRIÇÕES DE PRODUTOS

SKU	DESCRIÇÃO
3350	VT-8106 KIT DE MONTAGEM COM DIFUSOR PARA FITA DE LED DE ENCASTRAR 2000X24.7X7MM PRATA
3351	VT-8107 KIT DE MONTAGEM COM DIFUSOR PARA FITA DE LED DE ENCASTRAR 2000X24X14,2MM PRATA
3352	VT-8108 KIT DE MONTAGEM COM DIFUSOR PARA FITA DE LED DE SUPERFÍCIE 2000X23,5X10MM PRATA
3353	VT-8109 KIT DE MONTAGEM COM DIFUSOR PARA FITA DE LED DE CANTO 2000X15,8X15,8MM PRATA
3354	VT-8110 KIT DE MONTAGEM COM DIFUSOR PARA FITA DE LED DE SUPERFÍCIE 2000X17,2X14,44MM PRATA
3355	VT-8113 KIT DE MONTAGEM COM DIFUSOR PARA FITA DE LED DE SUPERFÍCIE 2000X17.4X7MM PRATA
3356	VT-8114 KIT DE MONTAGEM COM DIFUSOR PARA FITA DE LED DE CANTO 2000X19X19MM PRATEADO
3357	VT-8115 KIT DE MONTAGEM COM DIFUSOR PARA FITA DE LED DE ENCASTRAR 2000X24,5X12,2MM PRATA
3358	VT-8116 KIT DE MONTAGEM COM DIFUSOR PARA FITA DE LED DE SUPERFÍCIE 2000X17,4X12,1MM PRATA
3359	VT-8101 KIT DE MONTAGEM COM DIFUSOR PARA FITA DE LED RECESSADA 2000x61,5x14MM PRATA
3360	VT-8102 KIT DE MONTAGEM COM DIFUSOR PARA FITA DE LED RECESSADA 2000x52.1x13.3MM PRATA
3361	VT-8103 KIT DE MONTAGEM COM DIFUSOR PARA FITA DE LED 2000x50.12x22.34MM PRATA
3362	VT-8104 KIT DE MONTAGEM COM DIFUSOR PARA FITA DE LED RECESSADA 2000x45.4x25.14MM PRATA
3363	VT-8105 KIT DE MONTAGEM COM DIFUSOR PARA ESTRELAS DE LED DE CANTO 2000x20.3x30MM PRATA
3364	VT-8114-W KIT DE MONTAGEM COM DIFUSOR PARA FITA DE LED PCB 12MM CANTO 2000X19X19MM BRANCO
3365	VT-8113-W KIT DE MONTAGEM COM DIFUSOR PARA FITA DE LED PCB 12MM SUPERFÍCIE 2000X17.4X7MM BRANCO
3366	VT-8110-W KIT DE MONTAGEM COM DIFUSOR PARA FITA DE LED PCB 20MM SUPERFÍCIE 2000X17.2X14.44MM BRANCO
3367	VT-8108-W KIT DE MONTAGEM COM DIFUSOR PARA TIRA DE LED PCB 20MM SUPERFÍCIE 2000X23.5X10.4MM BRANCO
3368	VT-8122 KIT DE MONTAGEM COM DIFUSOR PARA FITA DE LED PCB 12MM ENCASTRADA 2000X24.7X7MM BRANCO
3369	VT-8123 KIT DE MONTAGEM COM DIFUSOR PARA FITA DE LED PCB 12MM CANTO 2000X15.8X15.8MM BRANCO
3370	VT-9327 KIT DE MONTAGEM COM DIFUSOR PARA FITA DE LED DE SUPERFÍCIE 2000X15,55X5,9MM PRATA
3371	VT-8118 KIT DE MONTAGEM COM DIFUSOR PARA FITA DE LED DE SUPERFÍCIE 2000X30X20MM PRATA
3372	VT-8119 KIT DE MONTAGEM COM DIFUSOR PARA FITA DE LED DE ENCASTRAR 2000X30X20MM PRATA

9956	VT-7104 KIT DE MONTAGEM COM DIFUSOR PARA FITA DE LED DE CANTO 2000MM PRATA (EMBALAGEM COM 2 UNIDADES)
2610	VT-8117 KIT DE MONTAGEM COM DIFUSOR PARA FITA DE LED DE SUPERFÍCIE 2000MM NEON FLEX
2871	VT-8126 KIT DE MONTAGEM COM DIFUSOR PARA FITA DE LED RECESSADA 2000x50x35mm BRANCO
2872	VT-8127 KIT DE MONTAGEM COM DIFUSOR PARA FITAS DE LED SUPERFICIAIS 2000x50x75mm BRANCO
2873	VT-8113 KIT DE MONTAGEM COM DIFUSOR PARA FITA DE LED 2000x17.4x7mm PRETO
2874	VT-8109 KIT DE MONTAGEM COM DIFUSOR PARA FITA DE LED 2000x15.8x15.8mm PRETO
2875	VT-8106 KIT DE MONTAGEM COM DIFUSOR PARA FITA DE LED 2000x24.7x7mm PRETO
2876	VT-8108 KIT DE MONTAGEM COM DIFUSOR PARA FITA DE LED 2000x23.5x10mm PRETO
2877	VT-8114 KIT DE MONTAGEM COM DIFUSOR PARA FITA DE LED 2000x19x19mm PRETO
2878	VT-8110 KIT DE MONTAGEM COM DIFUSOR PARA FITA DE LED 2000x17.2x14.4mm PRETO
2903	VT-8136 KIT DE MONTAGEM COM DIFUSOR PARA FITA DE LEDS COM 2000MM DE SUPERFÍCIE
2904	VT-8137 KIT DE MONTAGEM COM DIFUSOR PARA FITA DE LED ENCASTRADA 2000MM
2909	VT-8138 KIT DE MONTAGEM COM DIFUSOR BENEFICIADO PARA FITA DE LED 2000x18x6MM CORPO DE PRATA
10320	VT-8156 KIT DE MONTAGEM COM DIFUSOR PARA FITA DE LED 2000x24.7x7mm
10321	VT-8157 KIT DE MONTAGEM COM DIFUSOR PARA FITA DE LED 2000x17.4x7mm
10322	VT-8158 KIT DE MONTAGEM COM DIFUSOR PARA FITA DE LED 2000x15,8mmx15,8mm
23173	VT-8201 KIT DE MONTAGEM COM DIFUSOR PARA FITA DE LED 2000x55x15mm CORPO PRATA
23174	VT-8202 KIT DE MONTAGEM COM DIFUSOR PARA FITA DE LED 2000x20x10mm CORPO PRATA
23175	VT-8203 KIT DE MONTAGEM COM DIFUSOR PARA FITA DE LED 2000x20x10mm CORPO PRATA
23176	VT-8204S KIT DE MONTAGEM COM DIFUSOR PARA FITA DE LED 2000x30x10mm CORPO PRATA
23177	VT-8204 KIT DE MONTAGEM COM DIFUSOR PARA FITA DE LED 2000x30x10mm CORPO PRATA
23178	VT-8206S KIT DE MONTAGEM COM DIFUSOR PARA FITA DE LED 2000x50x20mm CORPO PRATA
23179	VT-8206 KIT DE MONTAGEM COM DIFUSOR PARA FITA DE LED 2000x50x20mm CORPO PRATA
23180	VT-8208 KIT DE MONTAGEM COM DIFUSOR PARA FITA DE LED 2000x60x36mm CORPO PRATA

MANUAL DE INSTRUCȚIUNI

PROFIL DIN ALUMINIU

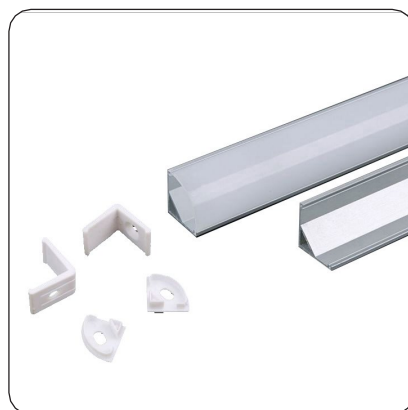

02 METER
LENGTH

INTRODUCERE

Vă mulțumim pentru selectarea și cumpărarea produsului V-TAC. V-TAC vă va oferi cele mai bune servicii. Vă rugăm să citiți cu atenție aceste instrucțiuni înainte de a începe instalarea și să păstrați acest manual la îndemână pentru consultare ulterioară. Dacă aveți orice altă întrebare, vă rugăm să contactați distribuitorul nostru sau vânzătorul local de la care ați achiziționat produsul. Aceștia sunt instruiți și pregătiți să vă servească la cel mai bun nivel.

ÎNTREȚINERE

- **Precauții înainte de curățare:** Înainte de a curăța produsul, asigurați-vă că acesta este deconectat de la rețeaua electrică. Aceasta este o măsură de siguranță esențială pentru a preveni orice accident electric.
- **Procedura de curățare:** Utilizați o cârpă de bumbac ușor umezită cu alcool pentru a curăța rama. Abțineți-vă de la folosind agenți chimici puternici. Este imperativ să vă asigurați că lichidul nu intră în contact cu componentele electrice ale produsului.
- **Măsuri de siguranță:** Curățarea nu trebuie efectuată de copii sub vârsta de 8 ani, cu excepția cazului în care aceștia sunt sub supravegherea unui adult. Acest lucru este menit să asigure siguranța copilului și manipularea corectă a produsului.
- **Tăierea profilului:** Fixați profilul de aluminiu în poziție folosind o menhină sau cleme pentru a vă asigura că nu se mișcă în timpul tăierii. Asigurați-vă că tăietura este cât mai dreaptă posibil pentru cea mai bună potrivire.
- **Netezirea marginilor:** După tăiere, marginile profilului de aluminiu pot fi ascuțite sau inegale. Utilizați o pilă pentru a neteziți-le, având grijă să îndepărtați orice bavuri metalice care ar putea provoca daune.



Acest marcaj indică faptul că acest produs nu trebuie eliminat împreună cu alte deșeuri menajere.

INSTRUCȚIUNI DE INSTALARE

INSTALARE ÎNCASTRATĂ

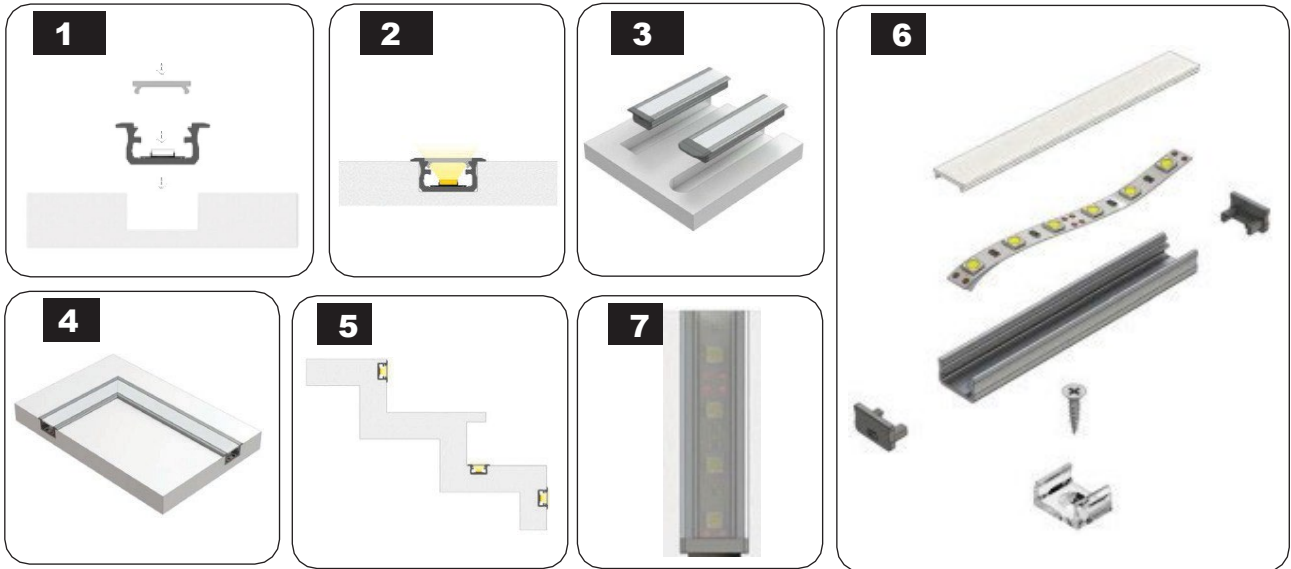

INSTALARE PE SUPRAFAȚĂ



INSTALAREA GIPSULUI

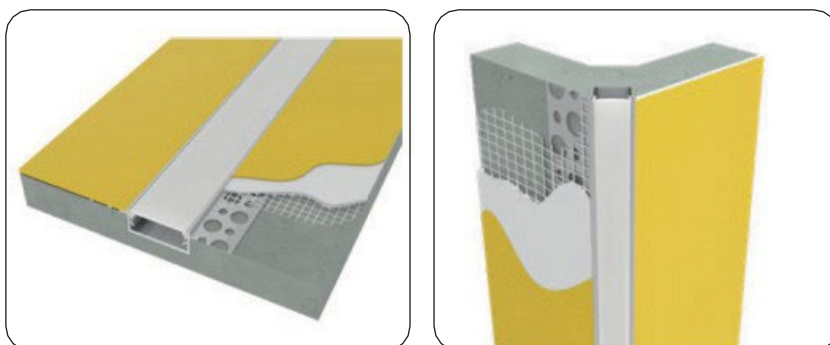

INSTALARE PE COLȚ

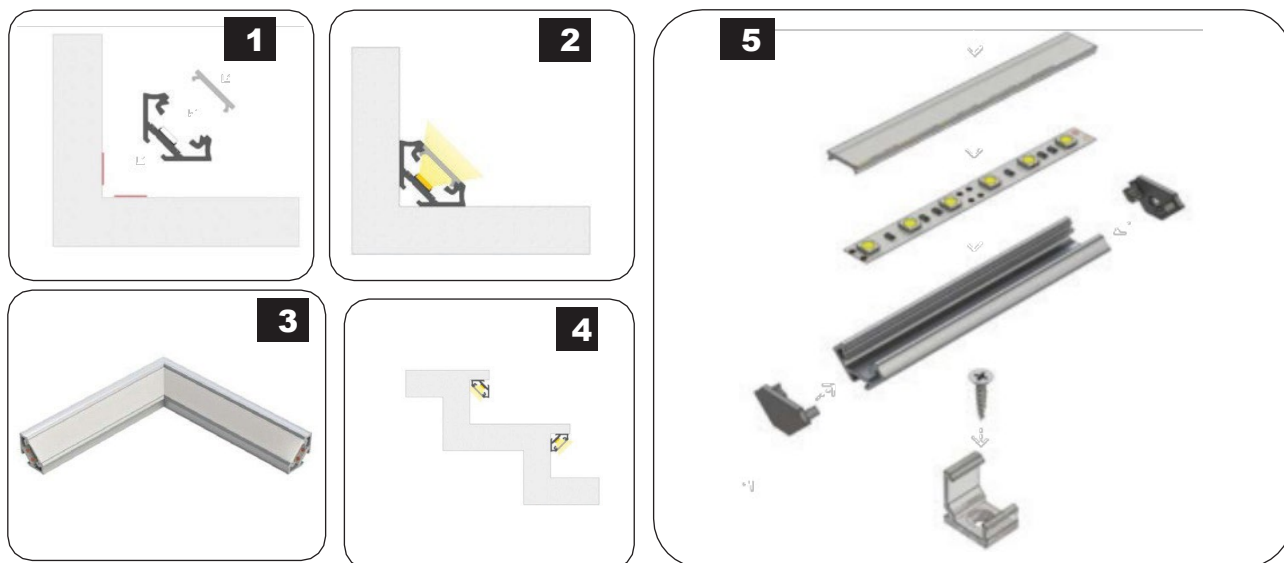

DESCRIERI DE PRODUSE

SKU	DESCRIERE
3350	VT-8106 KIT DE MONTARE CU DIFUZOR PENTRU BENZI CU LEDURI ÎNCASTRATE 2000X24.7X7MM ARGINTIU
3351	VT-8107 KIT DE MONTARE CU DIFUZOR PENTRU BENZI CU LEDURI ÎNCASTRATE 2000X24X14.2MM ARGINTIU
3352	VT-8108 KIT DE MONTARE CU DIFUZOR PENTRU BANDĂ CU LEDURI DE SUPRAFAȚĂ 2000X23.5X10MM ARGINTIU
3353	VT-8109 KIT DE MONTAJ CU DIFUZOR PENTRU BENZI LED COLȚ 2000X15.8X15.8MM ARGINTIU
3354	VT-8110 KIT DE MONTARE CU DIFUZOR PENTRU BANDĂ CU LEDURI DE SUPRAFAȚĂ 2000X17.2X14.44MM ARGINTIU
3355	VT-8113 KIT DE MONTARE CU DIFUZOR PENTRU BANDĂ CU LEDURI DE SUPRAFAȚĂ 2000X17.4X7MM ARGINTIU
3356	VT-8114 KIT DE MONTARE CU DIFUZOR PENTRU BENZI CU LEDURI COLȚ 2000X19X19MM ARGINTIU
3357	VT-8115 KIT DE MONTARE CU DIFUZOR PENTRU BENZI CU LEDURI ÎNCASTRATE 2000X24.5X12.2MM ARGINTIU
3358	VT-8116 KIT DE MONTARE CU DIFUZOR PENTRU BANDĂ CU LEDURI DE SUPRAFAȚĂ 2000X17.4X12.1MM ARGINTIU
3359	VT-8101 KIT DE MONTAJ CU DIFUZOR PENTRU LED STRIP RECESSED 2000x61.5x14MM SILVER
3360	VT-8102 KIT DE MONTAJ CU DIFUZOR PENTRU LED STRIP RECESSED 2000x52.1x13.3MM SILVER
3361	VT-8103 KIT DE MONTAJ CU DIFUZOR PENTRU LED STRIP 2000x50.12x22.34MM SILVER
3362	VT-8104 KIT DE MONTAJ CU DIFUZOR PENTRU LED STRIP RECESSED 2000x45.4x25.14MM SILVER
3363	VT-8105 KIT DE MONTAJ CU DIFUZOR PENTRU LED STRIP CORNER 2000x20.3x30MM SILVER
3364	VT-8114-W KIT DE MONTAJ CU DIFUZOR PENTRU BANDĂ LED PCB 12MM COLȚ 2000X19X19MM ALB
3365	VT-8113-W KIT DE MONTAJ CU DIFUZOR PENTRU BANDĂ LED PCB 12MM SUPRAFAȚĂ 2000X17.4X7MM ALB
3366	VT-8110-W KIT DE MONTARE CU DIFUZOR PENTRU BANDĂ LED PCB 20MM SUPRAFAȚĂ 2000X17.2X14.44MM ALB
3367	VT-8108-W KIT DE MONTARE CU DIFUZOR PENTRU BANDĂ LED PCB 20MM SUPRAFAȚĂ 2000X23.5X10.4MM ALB
3368	VT-8122 KIT DE MONTARE CU DIFUZOR PENTRU BENZI CU LEDURI PCB 12MM ÎNCASTRATE 2000X24.7X7MM ALB
3369	VT-8123 KIT DE MONTAJ CU DIFUZOR PENTRU BANDĂ LED PCB 12MM COLȚ 2000X15.8X15.8MM ALB
3370	VT-9327 KIT DE MONTARE CU DIFUZOR PENTRU BANDĂ CU LEDURI DE SUPRAFAȚĂ 2000X15.55X5.9MM ARGINTIU
3371	VT-8118 KIT DE MONTARE CU DIFUZOR PENTRU BANDĂ CU LEDURI DE SUPRAFAȚĂ 2000X30X20MM ARGINTIU
3372	VT-8119 KIT DE MONTARE CU DIFUZOR PENTRU BENZI CU LEDURI ÎNCASTRATE 2000X30X20MM ARGINTIU

9956	VT-7104 KIT DE MONTARE CU DIFUZOR PENTRU BENZI LED COLȚ 2000MM ARGINTIU (PACHET DE 2 BUC)
2610	VT-8117 KIT DE MONTARE CU DIFUZOR PENTRU BANDĂ CU LED DE SUPRAFAȚĂ 2000MM NEON FLEX
2871	VT-8126 KIT DE MONTAJ CU DIFUZOR PENTRU LED STRIP RECESSED 2000x50x35mm ALB
2872	VT-8127 KIT DE MONTAJ CU DIFUZOR PENTRU LED STRIP SURFACE 2000x50x75mm ALB
2873	VT-8113 KIT DE MONTAJ CU DIFUZOR PENTRU LED STRIP 2000x17.4x7mm NEGRU
2874	VT-8109 KIT DE MONTAJ CU DIFUZOR PENTRU LED STRIP 2000x15.8x15.8mm NEGRU
2875	VT-8106 KIT DE MONTAJ CU DIFUZOR PENTRU LED STRIP 2000x24.7x7mm NEGRU
2876	VT-8108 KIT DE MONTAJ CU DIFUZOR PENTRU LED STRIP 2000x23.5x10mm NEGRU
2877	VT-8114 KIT DE MONTAJ CU DIFUZOR PENTRU LED STRIP 2000x19x19mm NEGRU
2878	VT-8110 KIT DE MONTAJ CU DIFUZOR PENTRU LED STRIP 2000x17.2x14.4mm NEGRU
2903	VT-8136 KIT DE MONTARE CU DIFUZOR PENTRU BANDĂ CU LEDURI CU SUPRAFAȚĂ DE 2000MM
2904	VT-8137 KIT DE MONTARE CU DIFUZOR PENTRU BANDĂ CU LEDURI ÎNCASTRATE 2000MM
2909	VT-8138 KIT DE MONTAJ CU DIFUZOR BENDABIL PENTRU LED STRIP 2000x18x6MM SILVER HOUSING
10320	VT-8156 KIT DE MONTAJ CU DIFUZOR PENTRU LED STRIP 2000x24.7x7mm
10321	VT-8157 KIT DE MONTAJ CU DIFUZOR PENTRU LED STRIP 2000x17.4x7mm
10322	VT-8158 KIT DE MONTAJ CU DIFUZOR PENTRU LED STRIP 2000x15.8mmx15.8mm
23173	VT-8201 KIT DE MONTAJ CU DIFUZOR PENTRU LED STRIP 2000x55x15mm SILVER BODY
23174	VT-8202 KIT DE MONTAJ CU DIFUZOR PENTRU LED STRIP 2000x20x10mm SILVER BODY
23175	VT-8203 KIT DE MONTAJ CU DIFUZOR PENTRU LED STRIP 2000x20x10mm SILVER BODY
23176	VT-8204S KIT DE MONTAJ CU DIFUZOR PENTRU LED STRIP 2000x30x10mm SILVER BODY
23177	VT-8204 KIT DE MONTAJ CU DIFUZOR PENTRU LED STRIP 2000x30x10mm SILVER BODY
23178	VT-8206S KIT DE MONTAJ CU DIFUZOR PENTRU LED STRIP 2000x50x20mm SILVER BODY
23179	VT-8206 KIT DE MONTAJ CU DIFUZOR PENTRU LED STRIP 2000x50x20mm SILVER BODY
23180	VT-8208 KIT DE MONTAJ CU DIFUZOR PENTRU LED STRIP 2000x60x36mm SILVER BODY



Meaningful Innovation.

WEEE Number: 80133970

MANUAL DE INSTRUCCIONES

PERFIL DE ALUMINIO

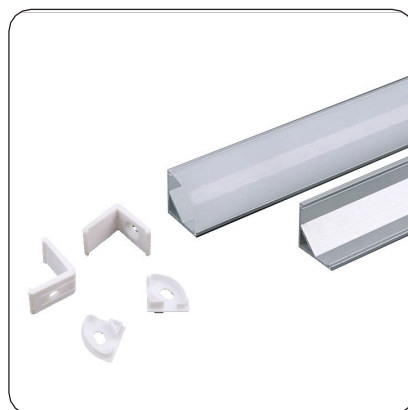

02 METER
LENGTH

INTRODUCCIÓN

Gracias por seleccionar y comprar un producto V-TAC. V-TAC le servirá lo mejor posible. Lea atentamente estas instrucciones antes de comenzar la instalación y conserve este manual a mano para futuras consultas. Si tiene cualquier otra duda, póngase en contacto con nuestro distribuidor o vendedor local al que haya comprado el producto. Están formados y preparados para atenderle lo mejor posible.

MANTENIMIENTO

- **Precauciones previas a la limpieza:** Antes de limpiar el producto, asegúrese de que está desconectado de la red eléctrica. Se trata de una medida de seguridad crucial para evitar cualquier percance eléctrico.
- **Procedimiento de limpieza:** Utilice un paño de algodón ligeramente humedecido con alcohol para limpiar el marco. No utilice agentes químicos potentes. Es imprescindible asegurarse de que el líquido no entre en contacto con los componentes eléctricos del producto.
- **Medidas de seguridad:** La limpieza no debe ser realizada por niños menores de 8 años, a menos que sean menores de supervisión de un adulto. Esto es para garantizar la seguridad del niño y la correcta manipulación del producto.
- **Corte del perfil:** Fije el perfil de aluminio en su lugar utilizando un tornillo de banco o abrazaderas para asegurarse de que no se mueva durante el corte. Asegúrese de que el corte es lo más recto posible para obtener el mejor ajuste.
- **Alise los bordes:** Después del corte, los bordes del perfil de aluminio pueden estar afilados o desiguales. Utilice una lima para alíselos, teniendo cuidado de eliminar cualquier rebaba metálica que pudiera causar daños.



Esta marca indica que este producto no debe eliminarse con otros residuos domésticos.

INSTRUCCIONES DE INSTALACIÓN

INSTALACIÓN EMPOTRADA

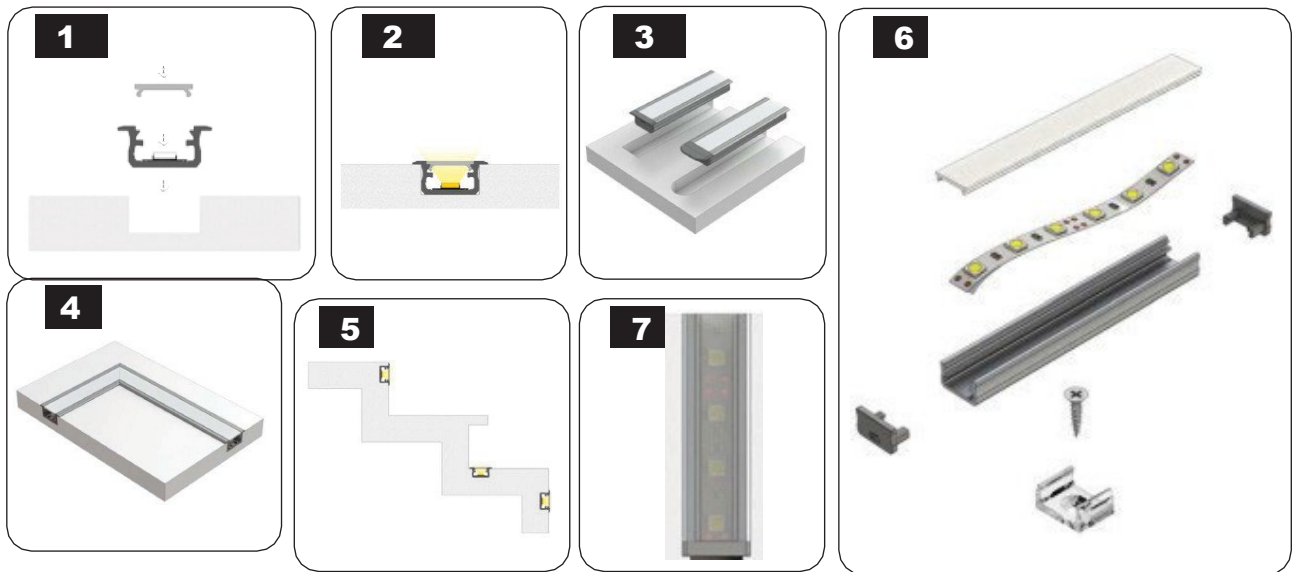

INSTALACIÓN EN SUPERFICIE



INSTALACIÓN DE YESO

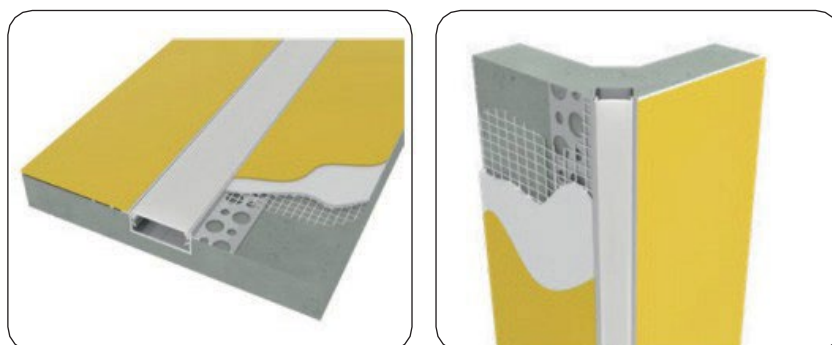

INSTALACIÓN EN ESQUINA

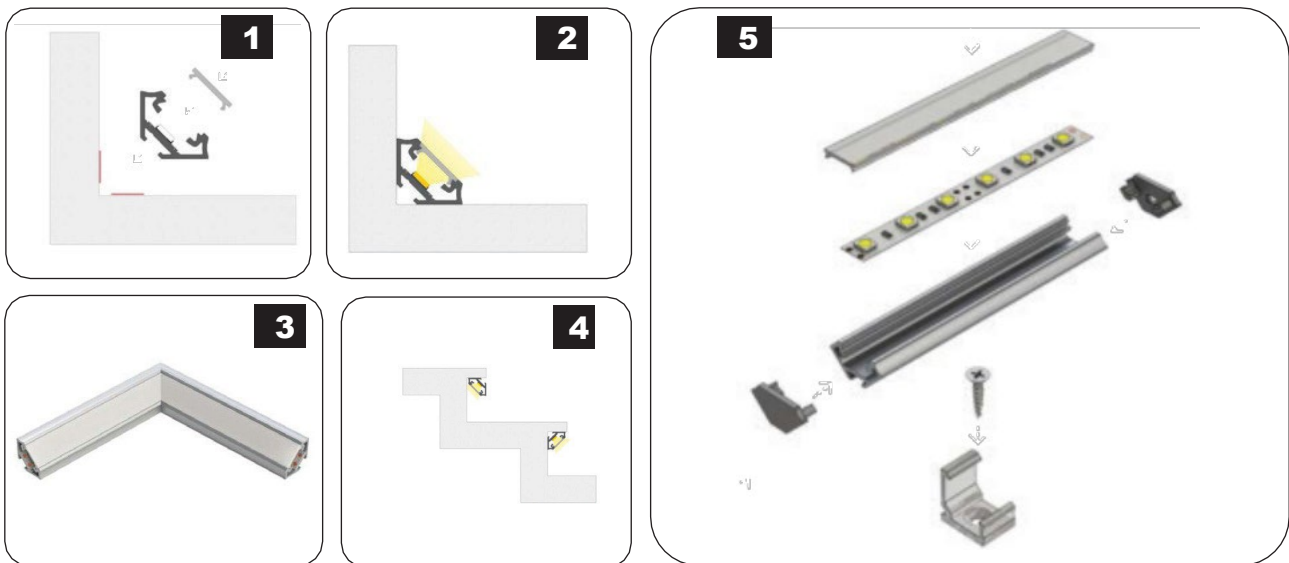

DESCRIPCIONES DE PRODUCTOS

SKU	DESCRIPCIÓN
3350	VT-8106 KIT DE MONTAJE CON DIFUSOR PARA TIRA LED EMPOTRABLE 2000X24.7X7MM PLATA
3351	VT-8107 KIT DE MONTAJE CON DIFUSOR PARA TIRA LED EMPOTRABLE 2000X24X14,2MM PLATA
3352	VT-8108 KIT DE MONTAJE CON DIFUSOR PARA TIRA LED SUPERFICIE 2000X23.5X10MM PLATA
3353	VT-8109 KIT DE MONTAJE CON DIFUSOR PARA TIRA LED ESQUINA 2000X15.8X15.8MM PLATA
3354	VT-8110 KIT DE MONTAJE CON DIFUSOR PARA TIRA LED SUPERFICIE 2000X17.2X14.44MM PLATA
3355	VT-8113 KIT DE MONTAJE CON DIFUSOR PARA TIRA LED SUPERFICIE 2000X17.4X7MM PLATA
3356	VT-8114 KIT DE MONTAJE CON DIFUSOR PARA TIRA LED RINCONERA 2000X19X19MM PLATA
3357	VT-8115 KIT DE MONTAJE CON DIFUSOR PARA TIRA LED EMPOTRABLE 2000X24.5X12.2MM PLATA
3358	VT-8116 KIT DE MONTAJE CON DIFUSOR PARA TIRA LED SUPERFICIE 2000X17.4X12.1MM PLATA
3359	VT-8101 KIT DE MONTAJE CON DIFUSOR PARA TIRAS LED EMPotRADAS 2000x61.5x14MM PLATA
3360	VT-8102 KIT DE MONTAJE CON DIFUSOR PARA TIRAS LED EMPotRADAS 2000x52.1x13.3MM PLATA
3361	VT-8103 KIT DE MONTAJE CON DIFUSOR PARA TIRAS DE LED 2000x50.12x22.34MM PLATA
3362	VT-8104 KIT DE MONTAJE CON DIFUSOR PARA TIRAS LED EMPotRADAS 2000x45.4x25.14MM PLATA
3363	VT-8105 KIT DE MONTAJE CON DIFUSOR PARA RINCÓN LED 2000x20.3x30MM PLATA
3364	VT-8114-W KIT DE MONTAJE CON DIFUSOR PARA TIRA LED PCB 12MM ESQUINA 2000X19X19MM BLANCO
3365	VT-8113-W KIT DE MONTAJE CON DIFUSOR PARA TIRA LED PCB 12MM SUPERFICIE 2000X17.4X7MM BLANCO
3366	VT-8110-W KIT DE MONTAJE CON DIFUSOR PARA TIRA LED PCB 20MM SUPERFICIE 2000X17.2X14.44MM BLANCO
3367	VT-8108-W KIT DE MONTAJE CON DIFUSOR PARA TIRA LED PCB 20MM SUPERFICIE 2000X23.5X10.4MM BLANCO
3368	VT-8122 KIT DE MONTAJE CON DIFUSOR PARA TIRA LED PCB 12MM EMPOTRABLE 2000X24.7X7MM BLANCO
3369	VT-8123 KIT DE MONTAJE CON DIFUSOR PARA TIRA LED PCB 12MM ESQUINA 2000X15.8X15.8MM BLANCO
3370	VT-9327 KIT DE MONTAJE CON DIFUSOR PARA TIRA LED SUPERFICIE 2000X15.55X5.9MM PLATA
3371	VT-8118 KIT DE MONTAJE CON DIFUSOR PARA TIRA LED SUPERFICIE 2000X30X20MM PLATA
3372	VT-8119 KIT DE MONTAJE CON DIFUSOR PARA TIRA LED EMPOTRABLE 2000X30X20MM PLATA

9956	VT-7104 KIT DE MONTAJE CON DIFUSOR PARA TIRA LED RINCONERA 2000MM PLATA(PACK 2UDS)
2610	VT-8117 KIT DE MONTAJE CON DIFUSOR PARA TIRA LED SUPERFICIE 2000MM NEON FLEX
2871	VT-8126 KIT DE MONTAJE CON DIFUSOR PARA TIRAS LED EMPotRADAS 2000x50x35mm BLANCO
2872	VT-8127 KIT DE MONTAJE CON DIFUSOR PARA BARRA LED SUPERFICIAL 2000x50x75mm BLANCO
2873	VT-8113 KIT DE MONTAJE CON DIFUSOR PARA TIRAS DE LED 2000x17.4x7mm NEGRO
2874	VT-8109 KIT DE MONTAJE CON DIFUSOR PARA TIRAS DE LED 2000x15.8x15.8mm NEGRO
2875	VT-8106 KIT DE MONTAJE CON DIFUSOR PARA TIRAS DE LED 2000x24.7x7mm NEGRO
2876	VT-8108 KIT DE MONTAJE CON DIFUSOR PARA TIRAS DE LED 2000x23.5x10mm NEGRO
2877	VT-8114 KIT DE MONTAJE CON DIFUSOR PARA BARRA LED 2000x19x19mm NEGRO
2878	VT-8110 KIT DE MONTAJE CON DIFUSOR PARA TIRAS DE LED 2000x17.2x14.4mm NEGRO
2903	VT-8136 KIT DE MONTAJE CON DIFUSOR PARA TIRA LED SUPERFICIE 2000MM
2904	VT-8137 KIT DE MONTAJE CON DIFUSOR PARA TIRA LED EMPOTRABLE 2000MM
2909	VT-8138 KIT DE MONTAJE CON DIFUSOR DOBLABLE PARA TIRAS LED 2000x18x6MM CARCASA PLATA
10320	VT-8156 KIT DE MONTAJE CON DIFUSOR PARA TIRAS DE LED 2000x24.7x7mm
10321	VT-8157 KIT DE MONTAJE CON DIFUSOR PARA TIRAS DE LED 2000x17.4x7mm
10322	VT-8158 KIT DE MONTAJE CON DIFUSOR PARA TIRAS DE LED 2000x15,8mmx15,8mm
23173	VT-8201 KIT DE MONTAJE CON DIFUSOR PARA BARRA LED 2000x55x15mm CUERPO PLATA
23174	VT-8202 KIT DE MONTAJE CON DIFUSOR PARA BARRA LED 2000x20x10mm CUERPO PLATA
23175	VT-8203 KIT DE MONTAJE CON DIFUSOR PARA BARRA LED 2000x20x10mm CUERPO PLATA
23176	VT-8204S KIT DE MONTAJE CON DIFUSOR PARA BARRA LED 2000x30x10mm CUERPO PLATA
23177	VT-8204 KIT DE MONTAJE CON DIFUSOR PARA BARRA LED 2000x30x10mm CUERPO PLATA
23178	VT-8206S KIT DE MONTAJE CON DIFUSOR PARA BARRA LED 2000x50x20mm CUERPO PLATA
23179	VT-8206 KIT DE MONTAJE CON DIFUSOR PARA BARRA LED 2000x50x20mm CUERPO PLATA
23180	VT-8208 KIT DE MONTAJE CON DIFUSOR PARA BARRA LED 2000x60x36mm CUERPO PLATA
